

Safety Barriers

Single-channel safety barriers



9001/01-086-150-101 Art. No. 158418



- For the intrinsically safe operation of a wide range of devices, such as HART transmitters, solenoid valves, sensors, contacts and many more
- Compact, space-saving devices that are easy to install on a DIN rail
- Quick and efficient installation as barriers can be simultaneously snapped onto DIN rail and connected to ground (ISA - RP12.06)
- Convenient maintenance and repair through back-up fuse feature

WebCode **9001A**



The 9001 series INTRINSPAK single-channel zener barriers enable the intrinsically safe operation of virtually all field devices. The comprehensive portfolio and the combination of zener barriers cover a wide variety of signals. The devices are incredibly robust and require little space. The back-up fuse is a convenient feature as it is standardized for all variants.

Technical Data

Explosion Protection

Application range (zones)	2
Ex interface zone	0 1 2 20 21 22
IECEX gas certificate	IECEX PTB 09.0001X
IECEX gas explosion protection	Ex nA [ia Ga] IIC/IIB T4 Gc
IECEX dust certificate	IECEX PTB 09.0001X
IECEX dust explosion protection	[Ex ia Da] IIIC
ATEX gas certificate	PTB 01 ATEX 2088 X
ATEX gas explosion protection	⊕ II 3 (1) G Ex nA [ia Ga] IIC/IIB T4 Gc
ATEX dust certificate	PTB 01 ATEX 2088 X
ATEX dust explosion protection	⊕ II (1) D [Ex ia Da] IIIC
Certificate FMus	3011002
Marking FMus	NONINCENDIVE FOR, Class I, Div. 2, Groups A,B,C,D; T4, Class I, Zone 2, Group IIC T4 IS connections for Class I,II,III, Div. 1, Groups A,B,C,D,E,F,G; Class I, Zone 0, Groups IIC/IIB Hazardous location when inst. per doc. 90 016 11 31 1
Certificate ULus	E81680V1S3
Marking ULus	For use in Hazardous location, Class I, Div. 2, Groups A,B,C,D; T4 Providing IS circuits for Class I,II,III, GROUPS A,B,C,D,E,F,G; per doc. 90 016 11 31 3
Certificate cCSA	1284547

9001/01-086-150-101 Art. No. 158418

Explosion Protection

Marking cCSA	Associated equipment [Ex ia], Class I, Div. 2, Groups A,B,C,D; Provides IS circuits for Class I,II,III, Class I, Zone 0, Groups IIC/IIB For applicable grps per inst. doc. 90 016 11 31 2
EAC certificate	TS RU C-DE.ГБ04.B.00652
EAC gas explosion protection	Ex 2 Ex nA [ia Ga] IIC T4 Gc X
EAC dust explosion protection	Ex [Ex ia Da] IIC
Inmetro gas certificate	UL-BR 12.0353
Inmetro dust certificate	UL-BR 12.0353
Certificates	ATEX (PTB), Brazil (ULB), Canada (CSA), EAC (STV), IECEx (PTB), Japan (CML), Korea (KGS), USA (FM), USA (UL)
Notes	CCC certificate available from 2021 onward
Installation	in Zone 2, Division 2 and in safe area
Further information	see respective certificate and operating instructions

Safety Data

Maximum voltage U_o	8.6 V
Maximum current I_o	150 mA
Maximum power P_o	322.5 mW
Max. permissible external capacitance C_o for IIC	6.2 μ F
Max. permissible external capacitance C_o for IIB	55 μ F
Max. permissible external inductance L_o for IIC	1.3 mH
Max. permissible external inductance L_o for IIB	7 mH

Electrical Data

Number of channels	1
Rated operational voltage DC	6 V
Maximum resistance R_{max}	73 Ω
Minimum resistance R_{min}	65 Ω
Maximum output current I_{max}	82 mA
Potential	Positive potential
Ohmic current limiting using frequency \geq 50 mA	\leq 100 kHz
Ohmic current limiting using frequency \leq 50 mA	\leq 50 kHz
Leakage current I_{leck} for U_N	\leq 2 μ A
Leakage current I_{leck} for U_N 2	(Unless specified otherwise)

Auxiliary Power

Nominal voltage	6 V
Power supply	Controlled, nominal voltage

Ambient Conditions

Ambient temperature	-20 °C ... +60 °C
Ambient temperature	-4°F ... +140°F
Storage temperature	-20 °C ... +75 °C

9001/01-086-150-101 Art. No. 158418

Ambient Conditions

Storage temperature	-4°F ... +167°F
Relative humidity max.	95% on average, no condensation
Temperature influence	≤ 0,25 %/10K

Mechanical Data

Degree of protection (IP)	IP40
Degree of protection note	according to IEC 60529
Terminal degree of protection (IP)	IP20
Enclosure material	Polyamide 6GF
Number of connection terminals	4
Connection cross section max.	1.5 mm ²
Connection cross-section AWG	... 16 AWG
Type of connection cable	Finely stranded Solid
Width	103 mm
Width inches	4.09 in
Length	12 mm
Length inches	0.48 in
Mounting depth	72 mm
Mounting depth inches	2.76 in
Weight	0.11 kg
Weight	0.24 lb

Mounting / Installation

Connection cross-section ground	4 mm ²
Cross-section ground AWG	12 AWG
Connection type	2 PA
Min. torque Nm	0.5 Nm
Min. torque lb / in	4.43 lb / in
Max. torque Nm	0.6 Nm
Max. torque lb / in	5.31 lb / in

Technical Drawings – Subject to Alterations

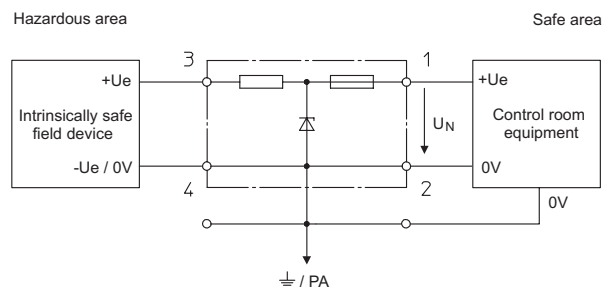

Single-Channel Safety Barriers for Positive Polarity

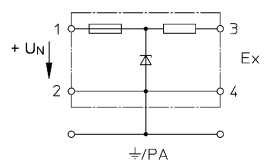

Picture B

9001/01-086-150-101 Art. No. 158418

Dimensional Drawings (All Dimensions in mm [inches]) – Subject to Alterations

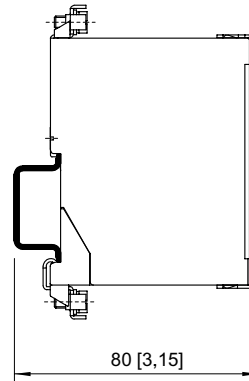
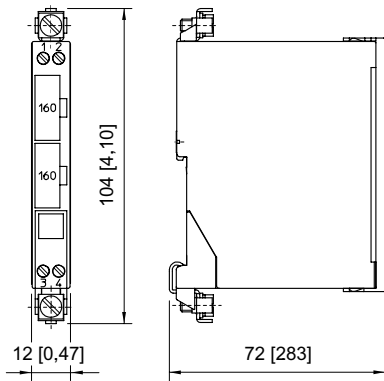

Mounting on DIN rail NS 35/15

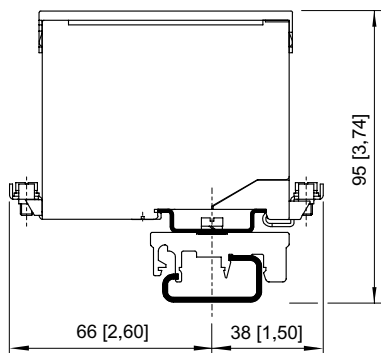

Mounting on DIN rail NS 32 by means of adaptor and mounting attachment, moulded plastic

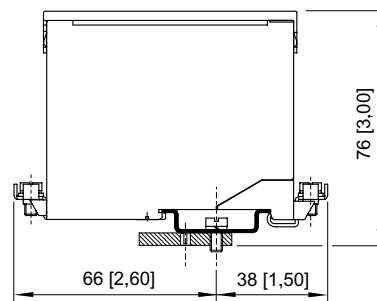

Mounting on mounting plate by means of adaptor

Accessories and Spare Parts

Back-up fuse

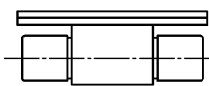

For all safety barriers Series 9001, 9002 and 9004
Packaging unit: 5 pcs.

Art. No.

158964

Holder for label

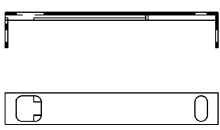

Transparent cover for labelling

Art. No.

158977

Labelling paper

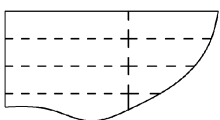

Perforated, for typing
Format: DIN A4
Packaging unit: 80 pieces

Art. No.

158973

Adaptor

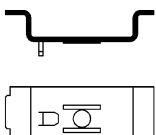

Adaptor allows installation of a safety barrier Series 900x on a mounting plate of a previous series.

Art. No.

158826

9001/01-086-150-101 Art. No. 158418

Mounting attachment moulded plastic

Art. No.

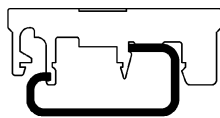

Enables mounting of safety barrier on a G-rail.

165283

Protective conductor terminal

Art. No.

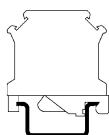

USLKG 5 (wire range 4 mm²)
Terminal enables connection of protective conductors to DIN rail. Colour green-yellow.

112760

Earth terminal

Art. No.

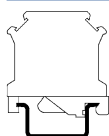

USLKG 6 N (wire range 6 mm²)
Terminal enables connection of protective / earthing conductors to DIN rail. Colour green-yellow.

112599

Fuse holder

Art. No.

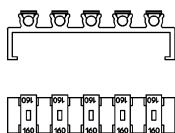

Fuse holder is snapped onto the side of the safety barrier and can be equipped with up to 5 back-up fuses (replacement).

158834

Insulating stand off

Art. No.

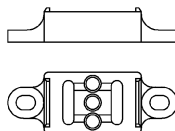

Suitable for DIN rail NS35/15, allows electrically insulated mounting of DIN rail from mounting plate.

158828

We reserve the right to make alterations to the technical data, dimensions, weights, designs and products available without notice. The illustrations cannot be considered binding.