

## Remote I/O

### Remote I/O IS1+ HART analog universal module

For Zone 2 Ex i

9468/33-08-10 Art. No. 210660



- Eight channels can be used individually as inputs or outputs
- Intrinsically safe Ex ia IIC inputs/outputs with line fault monitoring
- Module in Zone 2, Cl. I, II, Div. 2 can be hot swapped

WebCode 9468B



The 9468/33 series HART Analog Universal Module for Zone 2, Cl. I, II, Div. 2 has eight channels that can be used individually for Ex i operating two-/three-conductor HART transmitters, four-conductor transmitters or control valves/positioners with 0/4 to 20 mA signals. HART communication is bidirectional. All inputs/outputs are short-circuit proof, galvanically separated from the system and individually monitored to check for line faults.

## Technical Data

### Explosion Protection

Application range (Zones)	2
Application range (Zone) note	A suitable enclosure in accordance with the area of application must be used. Refer to the operating instructions.
Ex interface zone	0 1 2 20 21 22
IECEX certificate Gas	IECEX DEK 12.0054X
IECEX gas explosion protection	Ex ec ia [ia Ga] IIC T4 Gc
IECEX dust certificate	IECEX DEK 12.0054X
IECEX dust explosion protection	[Ex ia Da] IIIC
ATEX gas certificate	DEKRA 12 ATEX0173 X
ATEX gas explosion protection	Ex I 3 (1) G Ex ec ia [ia Ga] IIC T4 Gc
ATEX dust certificate	DEKRA 12 ATEX0173 X
ATEX dust explosion protection	Ex II (1) D [Ex ia Da] IIIC
Certificate FMus	FM17US0332X
Certificate cFM	FM16CA0134X
Marking cFMus	NI, Class I, Div. 2, Groups A,B,C,D; Class I, Zone 2, AEx/Ex nA ia [ia] IIC AIS Class I,II,III, Div. 1, Groups A,B,C,D,E,F,G; T4 at Ta = 75°C See Doc. 9468 6 031 002 1
EAC certificate	TS RU S-DE.GB04.B.00448
EAC gas explosion protection	Ex 2 Ex nA ia [ia Ga] IIC T4 Gc X
EAC dust explosion protection	Ex [Ex ia Da] IIIC

# Remote I/O

## Remote I/O IS1+ HART analog universal module

### For Zone 2 Ex i

9468/33-08-10 Art. No. 210660



#### Explosion Protection

Certificates	ATEX (DEK), Brazil (ULB), Canada (FM), EAC (STV), IECEx (DEK), India (PESO), Korea (KTL), Russia (Meteorological certificate), USA (FM)
Ship approval	EU RO MR
Notes	CCC certificate available from 2021 onward
Installation	Zone 2, Cl. I, Div. 2 and in the safe area
Further information	see operating instructions and certificate

#### Safety Data

Max. voltage $U_o/V_{oc}$	24.4 V								
Max. current $I_o$ (2-conductor)	80 mA								
Max. power $P_o$ (2-conductor)	488 mW								
Max. current $I_o$ (3-conductor)	81.8 mA								
Max. power $P_o$ (3-conductor)	499 mW								
Internal capacitance $C_i$	Negligible								
Internal inductance $L_i$	Negligible								
Max. connectable inductance $L_o$ / capacity $C_o$									
2-wire input/output									
IIC	$L_o$ [mH]	3.8	2	1	0.5	0.2			
	$C_o$ [nF]	53	59	71	88	119			
IIB	$L_o$ [mH]	23	10	2	1	0.5	0.2	0.1	0.05
	$C_o$ [nF]	370	430	430	470	550	700	860	890
3-wire input									
IIC	$L_o$ [mH]	3.6	2	1	0.5	0.2			
	$C_o$ [nF]	53	58	70	87	119			
IIB	$L_o$ [mH]	21	10	2	1	0.5	0.2	0.1	0.05
	$C_o$ [nF]	380	420	420	470	550	700	860	890

Limits																											
4-conductor transmitter	<p><math>U_o</math>, <math>I_o</math>, <math>P_o</math>, <math>C_i</math> and <math>L_i</math> are negligible.  Maximum connectable safety characteristic values during operation with active 4-wire-transmitters:</p> <table border="1"> <thead> <tr> <th>Max. input voltage <math>U_i</math> [V]</th> <th>Max. input current <math>I_i</math> [mA]</th> <th>Max. ambient temperature <math>T_{amb}</math> [°C]</th> </tr> </thead> <tbody> <tr> <td>28</td> <td>150</td> <td>55</td> </tr> <tr> <td>28</td> <td>140</td> <td>60</td> </tr> <tr> <td>28</td> <td>130</td> <td>65</td> </tr> <tr> <td>28</td> <td>115</td> <td>70</td> </tr> <tr> <td>28</td> <td>105</td> <td>75</td> </tr> </tbody> </table>									Max. input voltage $U_i$ [V]	Max. input current $I_i$ [mA]	Max. ambient temperature $T_{amb}$ [°C]	28	150	55	28	140	60	28	130	65	28	115	70	28	105	75
Max. input voltage $U_i$ [V]	Max. input current $I_i$ [mA]	Max. ambient temperature $T_{amb}$ [°C]																									
28	150	55																									
28	140	60																									
28	130	65																									
28	115	70																									
28	105	75																									

#### Electrical Data

Number of channels	8 Ex i inputs/outputs
Channels	each with adjustable parameters as input or output (3-wire, 4-wire transmitters, or active mA-sources occupy 2 channels)

# Remote I/O

## Remote I/O IS1+ HART analog universal module

### For Zone 2 Ex i

9468/33-08-10 Art. No. 210660



#### Electrical Data

Notes	In order to operate an active 4-wire HART transmitter, a 9164 must be connected between each channel. 9164 is not required when operating 4-wire transmitter without HART communication.
Nominal signal	4 ... 20 mA 0 ... 20 mA
Min. signal	0 mA
Supply voltage	16 V, at 20 mA for 2-wire transmitters
Communication signal	HART protocol
Connection Ex i field signals	Pluggable, blue terminals, 16-pole, 2.5 mm <sup>2</sup> , screw- or spring-type versions with lock

Signal transmission		Filter time constant (adjustable parameters)		
		small	small	small
	Resolution in the range 4 ... 20 mA	14.75 bit (with HART: 12.75 bit)	14.75 bit	14.75 bit
	Maximum delay from signal / internal bus	32 ms	120 ms	500 ms

#### Auxiliary Power

Power supply connection	BusRail types 9494
Auxiliary power version	Intrinsically safe Ex ia via BusRail
Current consumption	220 mA (at 20 mA per channel)
Max. power consumption	5.3 W (at 20 mA / channel)
Max. power dissipation outputs	3.7 W (at 20 mA, 500 Ω / channel)
Max. power dissipation inputs	2.7 W (at 20 mA / channel)

#### Galvanic Isolation

Test voltage for gal. separation	According to standard EN 60079-11
Auxiliary power/system components	≥ 1500 V AC
I/O module / I/O module	≥ 500 V AC
I/O channels/system components	≥ 500 V AC
I/O channels / ground (PA)	≥ 500 V AC

#### Input

Max. signal for input	23.5 mA
Max. input short-circuit current	24 mA
Max. input resistance	14.1 Ω per channel

#### Output

Output step response (10 ... 90 %)	40 ms
Max. output short-circuit current	22,8 mA (4 ... 20 mA) 23,5 mA (0 ... 20 mA)
Max. signal for output	22.8 mA (4 ... 20 mA) 23.5 mA (0 ... 20 mA)
Output load resistance max.	750 Ω at 20 mA 700 Ω at 21.8 mA

#### Device Specific Data

Signal type	Output Input
Diagnostics message module	ON OFF

# Remote I/O

## Remote I/O IS1+ HART analog universal module

For Zone 2 Ex i

9468/33-08-10 Art. No. 210660



### Device Specific Data

Signal filter module	50 Hz large 60 Hz large medium small
Scan HART live list module	ON OFF
Signal range	0 ... 20 mA 4 ... 20 mA
Input measuring range	3.6 ... 21 mA (acc. to NAMUR) 2.4 ... 22.8 or 23.5 mA
Line fault monitoring	OFF ON
Input behaviour in case of error	110% 100% 0% -10% Alarm code, keep last value
Output behaviour in case of error	-10% 0% 100% 110% Keep last value
Cyc. transmission of HART var.	No 8HV 4HV
LED module requires maintenance	"M/S" LED, blue
LED operating conditions	"RUN" LED, green
LED group error	"ERR" LED, red
Retrievable parameters	Type Software revision Serial number Manufacturer Hardware revision
Module status and alarms	Internal bus error primer / redundant No response from IOM Configuration does not correspond to the module Hardware error Excess temperature Slot error Module requires maintenance
Signal status bit	1 = Signal valid 0 = Signal interrupted
Wire breakage input	< 2,4 mA / 3,6 mA (adjustable param., at 4 ... 20)
Short circuit input	> 23,5 mA > 22,8 mA / > 21 mA (adjustable parameters)
Wire breakage output	Terminal voltage > 16 V (response range 16 ... 16.5 V) or output current can not longer be set
Short circuit output	Output load < 60 Ω (response range 40 ... 60 Ω )
Influence of ambient temperature	< 0,03 % / 10 K

# Remote I/O

## Remote I/O IS1+ HART analog universal module

### For Zone 2 Ex i

9468/33-08-10 Art. No. 210660



#### Accuracy of measurement

Error of measurement with filter time constant	small	medium	50 Hz, 60 Hz
Maximum error of measurement	0.075 % (12 mA at 4 ... 20 mA)	0.05 % (8 mA at 4 ... 20 mA)	0.05 % (8 mA at 4 ... 20 mA)

Note: All values in % of the signal span at 23 °C

#### Ambient Conditions

Ambient temperature °C	-40 °C ... +75 °C Observe operating instructions
Ambient temperature °F	-40°F ... +167°F Observe operating instructions
Storage temperature °C	-40 °C ... +80 °C
Storage temperature °F	-40°F ... +176°F
Max. operating altitude	< 2000 m
Max. relative humidity	95% (without condensation)
Shock (semi-sinusoidal)	(IEC EN 60068-2-27) 15 g (3 shocks per axis and direction)
Vibration (sinusoidal)	(IEC EN 60068-2-6) Frequency range 2 ... 13.2 Hz Amplitude 1 mm (peak value) Frequency range 13.2 ... 100 Hz Acceleration amplitude 0.7 g
Electromagnetic compatibility	Tested to the following standards and regulations: EN 61326-1 (2006) IEC 61000-4-1 to 61000-4-6, NAMUR NE 21

#### Mechanical Data

Degree of protection IP (IEC 60529)	IP20
Module enclosure	Polyamide 6GF
Fire resistance (UL 94)	V2
Pollutant class	Corresponds to G3
Width	96.5 mm
Width inches	3.8 in
Depth	68 mm
Length	128 mm
Length inches	5.04 in
Mounting depth inches	2.64 in
Weight	0.275 kg
Weight	0.61 lb

#### Mounting / Installation

Mounting position	Horizontal Vertical
-------------------	------------------------

# Remote I/O

## Remote I/O IS1+ HART analog universal module

### For Zone 2 Ex i

9468/33-08-10 Art. No. 210660



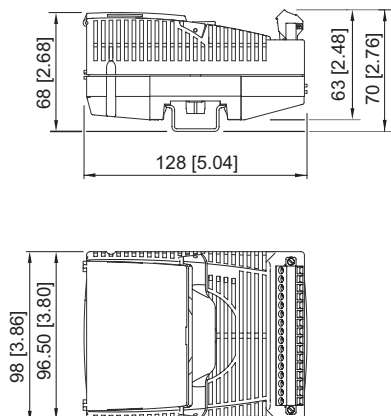

#### Dimensional Drawings (All Dimensions in mm [inches]) – Subject to Alterations



#### Accessories and Spare Parts

##### Pluggable terminal

		Art. No.
	2.5 mm <sup>2</sup> with lock, 16-pole, screw connector, blue, for connecting the field signals to I/O modules, for intrinsically safe field circuits Labelling: 1 ... 16 Attention: An additional terminal is necessary for I/O module Series 9470 and 9482. Labelling: 17 ... 32	162702
	2.5 mm <sup>2</sup> with lock, 16-pole, spring clamp connection, blue, for connecting the field signals to I/O modules, for intrinsically safe field circuits, incl. test jacks Labelling: 1 ... 16 Attention: An additional terminal is necessary for I/O module Series 9470 and 9482. Labelling: 17 ... 32	162695

##### Electronic relay

		Art. No.
	The electronic relay modules are used to switch from Ex e loads via intrinsically safe (Ex i) or non-intrinsically safe (Ex e) control. Coil circuit: Ex i or non-Ex i (Ex e)* Contact circuit: Non-Ex i (Ex e) *You can switch between Ex i and non-Ex i circuits, or vice-versa, at any time without restriction.	282457

##### Ex i/Ex e relay module for Zone 1

		Art. No.
	The Ex i/Ex e relay modules are used for the galvanically isolated switching of intrinsically safe circuits (Ex i) and non-Ex i (Ex e) electrical circuits. Coil circuit: Ex i or non-Ex i (Ex e)* Contact circuit: Ex i or non-Ex i (Ex e)* *You can switch between Ex i and non-Ex i circuits, or vice-versa, at any time without restriction	273000

##### mA-Isolating repeater

		Art. No.
	The mA isolating repeaters are used for the connection of 4-wire transmitters to active 2-wire inputs and for the galvanic separation. Input: sink, Ex e Output: sink, Ex i	224365





# Remote I/O

## Remote I/O IS1+ HART analog universal module

For Zone 2 Ex i

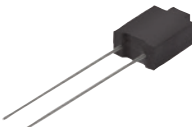
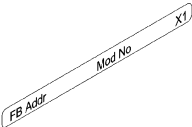
9468/33-08-10 Art. No. 210660



	The mA isolating repeaters are used for the connection of 4-wire transmitters to active 2-wire inputs and for the galvanic separation. Input: sink, Ex i Output: sink, Ex i	224364
<b>Resistor error message suppression</b>		<b>Art. No.</b>
	The resistors are used to suppress error messages for unused I/O channels Resistance value: 5K6 / 0.5 W Suitable for: AIM 9468; UMH 9469; DIOM 9470; DIOM 9471; DIOM 9472; DOM 9475 For intrinsically safe circuits (simple apparatus according to EN 60079-11)	244911
	The resistors are used to suppress error messages for unused I/O channels Resistance value: 62R / 0.5 W Suitable for: AOM 9468; UMH 9469; DIOM 9472; TIM 9482	244912
<b>Labelling strips</b>		<b>Art. No.</b>
	"FB Addr ... Mod No ..." for pluggable terminal, 26 pieces on the sheet	162788
<b>DIN A4 sheet</b>		<b>Art. No.</b>
	For the label plate on I/O modules, 6 labels per sheet Print IS Wizard, packaging unit = 20 sheets	162832
<b>Warning sign</b>		<b>Art. No.</b>
	"Clean modules only with a damp cloth."	162796
<b>Partition</b>		<b>Art. No.</b>
	For mounting between intrinsically safe and non-intrinsically safe connections of the I/O modules, in order to adhere to the required 50 mm distance	220101

We reserve the right to make alterations to the technical data, dimensions, weights, designs and products available without notice. The illustrations cannot be considered binding.