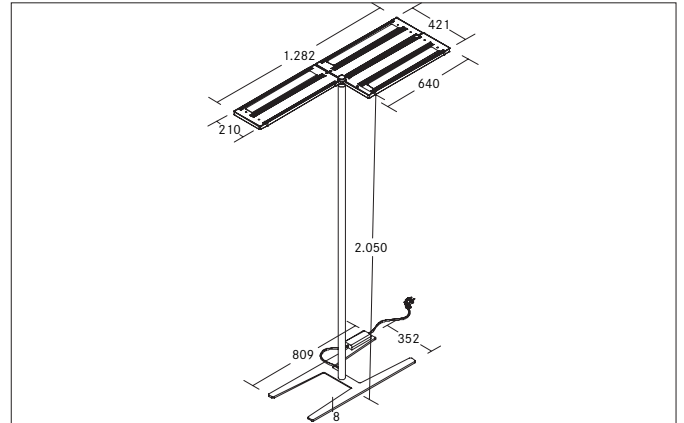

MELODY LED-Stehleuchte, NANO-prismatische Abdeckung, mit Indirektanteil, mit Sensorik, Taster und App

Article no. 77413694AI

Light.
For Generations.**Tender**

LED-Stehleuchte, NANO-prismatische Abdeckung, mit Indirektanteil, mit Sensorik, Taster und App, Rectangular. Luminaire length 1282.0 mm, Luminaire width 421.0 mm, Hight 2050.0 mm Weight 21.9 kg, double asymmetric optimal light distribution due to a plastic, microprismatic cover. Luminous flux 22.800 lm, UGR < 19, Power 180 W, Light colour neutral white, Correlated color temperature (CCT) 4.000 K, Colour rendering index CRI > 90, Housing material: Aluminium / Steel / Plastic, Colour: Silver, Permissible ambient temperature (ta): -20 °C - +25 °C, Protection class (EN 61140): I, Degree of protection (DIN EN 60529): IP20, .With electronic driver, Presence detector dimmable.

Article data	
Article no.	77413694AI
GTIN	4251433972136
Series name	MELODY
Short description	LED-Stehleuchte, NANO-prismatische Abdeckung, mit Indirektanteil, mit Sensorik, Taster und App
Material	Aluminium / Steel / Plastic
Colour	Silver
Type of surface	Structure
Shape	Rectangular
Length	1,282 mm
Width	421 mm
Hight	2050 mm
Scope of delivery	incl. supply line 2.500 mm with protective contact angle plug
Weight	21.900 kg

MELODY LED-Stehleuchte, NANO-prismatische Abdeckung, mit Indirektanteil, mit Sensorik, Taster und App

Article no. 77413694AI

Light.
For Generations.

Lighting technology	
Colour temperature	4.000 K
Light colour	White
Light output	Direct/Indirect
Luminous flux	22,800 lm
Luminous flux component (direct / indirect)	16/84 %
System efficiency	127 lm/W
McAdam-Step	McAdam-Step 3
Colour rendering	CRI > 90
Glare evaluation	UGR < 19
Luminance < 3,000 cd/m ² above 65° beam angle	Yes
Light sharing	Double asymmetric
Adjustable color temperature	No

Operating technology of the luminaire	
System output	180 W
Voltage type	AC
AC nominal voltage max	230 V
Frequency max	50 Hz
Lamp	LED
Lamp holder	Without fitting
Protection class	I
Degree of protection	IP20
Control	Presence detector, Daylight detector, Bluetooth, App, Button
Bulb change possible	The light source of this luminaire may only be replaced by the manufacturer or a service technician commissioned by him or a similarly qualified person.
Rated life time L90/B10 at 25 °C	50.000 h

Mounting technology	
Mounting method	Surface mounting
Place of installation	Floor-mounted
Adjustability	Not adjustable
Material cover	Plastic, microprismatic

Packing data	
Gross weight	23.6 kg
Length of packaging	2,085 mm
Packaging width	520 mm
Packaging height	95 mm
Disposal at end of life	This product must not be disposed of with household waste. You are obliged, to dispose of such electrical waste separately. By disposing of electrical waste and other old or defective electronics separately, you support recycling or other forms of re-use. In that way you help to take care and to avoid that harmful substances get into the environment.