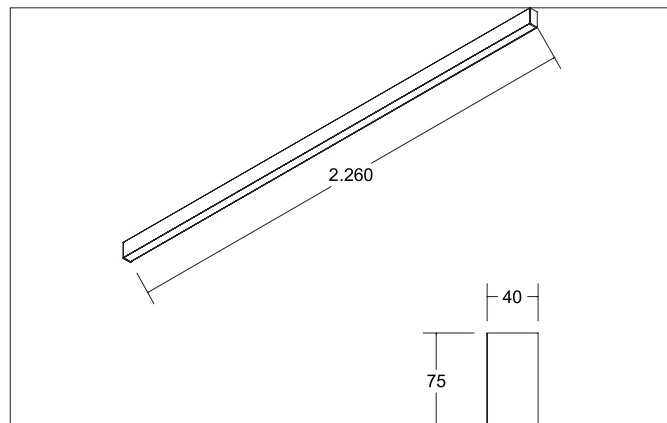
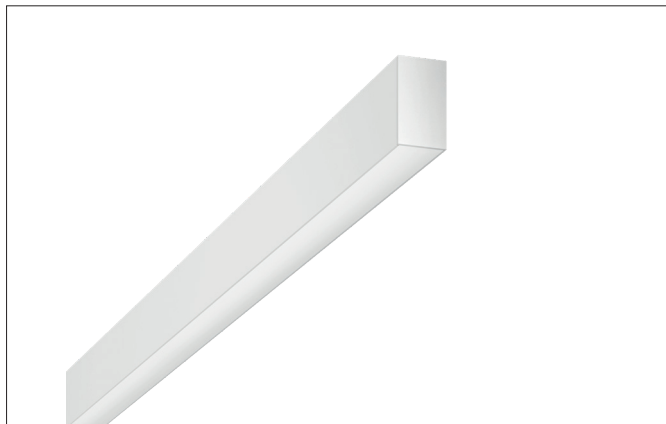

BIRO40 LED surface-mounted profile

Article no. 77144073

Light.
For Generations.**Tender**

LED surface-mounted profile, white, Rectangular. Mounting method: Surface mounting, Material: Aluminium / Acrylic, dimensions profile: length: 2.260 mm x width: 40 mm x height: 75 mm

Article data	
Article no.	77144073
GTIN	4251433949404
Series name	BIRO40
Short description	LED surface-mounted profile
Material	Aluminium / Acrylic
Colour	White
Shape	Rectangular
Length	2,260 mm
Width	40 mm
Hight	75 mm
Weight	3.790 kg

BIRO40 LED surface-mounted profile

Article no. 77144073

Light.
For Generations.

Lighting technology	
Colour temperature	3.000 K
Light colour	White
Light output	Direct
Luminous flux	4,850 lm
McAdam-Step	McAdam-Step 3
Colour rendering	CRI > 90
Luminaire optics	Cover satin
Reflector	Without
Beam angle	80°
Glare evaluation	UGR < 25
Light sharing	Symmetric

Operating technology of the luminaire	
Voltage type	AC
AC nominal voltage max	230 V
Frequenz max.	50 Hz
Lamp	LED
Protection class	I
Degree of protection	IP20
Control	DALI
Rated life time L70/B50 at 25 °C	60,000 h
Rated life time L80/B50 at 25 °C	60.000 h

Mounting technology	
Mounting method	Surface mounting
Place of installation	Ceiling-mounted
Adjustability	Not adjustable
Material cover	Plastic, satinised

Packing data	
Gross weight	4.58 kg
Length of packaging	2,300 mm
Packaging width	160 mm
Packaging height	135 mm
Disposal at end of life	This product must not be disposed of with household waste. You are obliged, to dispose of such electrical waste separately. By disposing of electrical waste and other old or defective electronics separately, you support recycling or other forms of re-use. In that way you help to take care and to avoid that harmful substances get into the environment.