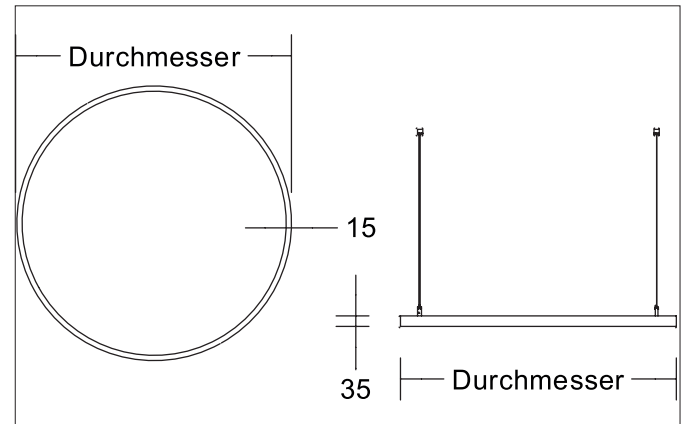

ANDROS OUT LED pendant ring luminaire, Casambi dimmable

Article no. 84072173CA

Light.
For Generations.**Tender**

LED pendant ring luminaire, Casambi dimmable, Round. Luminaire diameter 1200.0 mm, Height 35.0 mm, for pendulum mounting. Pendulum length max. 5000.0 mm Weight 9.0 kg, with rotationssymmetrical, deep, wide distributed light intensity. optimal light distribution due to a plastic, opal cover. Luminous flux 5.530 lm, UGR < 22, Power 1 x 58 W, Light colour warm white, Correlated color temperature (CCT) 3.000 K, Colour rendering index CRI > 90, Rated life time L70/B50 at 25 °C: 50.000 h, Housing material: Aluminium / Steel / Plastic, Colour: White structure, Permissible ambient temperature (ta): -20 °C - +25 °C, Protection class (EN 61140): I, Degree of protection (DIN EN 60529): IP20, .With electronic driver, Casambi dimmable.

Article data	
Article no.	84072173CA
GTIN	4255752508427
Series name	ANDROS OUT
Short description	LED pendant ring luminaire, Casambi dimmable
Material	Aluminium / Steel / Plastic
Colour	White
Type of surface	Structure
Shape	Round
Outer diameter	1200 mm
Height	35 mm
Weight	9.000 kg
Conformance	CE, UKCA

ANDROS OUT LED pendant ring luminaire, Casambi dimmable

Article no. 84072173CA

Light.
For Generations.

Lighting technology	
Colour temperature	3.000K
Light colour	White
Light output	Indirect
Luminous flux	5,530 lm
System efficiency	95 lm/W
McAdam-Step	McAdam-Step 3
Colour rendering	CRI > 90
Reflector	Without
Beam angle	110°
Glare evaluation	UGR < 22
Light sharing	Symmetric
Adjustable color temperature	No

Operating technology of the luminaire	
System output	58 W
Voltage type	AC
AC nominal voltage max	230 V
Frequency max	50 Hz
Lamp	LED
Lamp holder	LED
Protection class	I
Degree of protection	IP20
Dimmable	Yes
Control	Casambi
Bulb change possible	The light source of this luminaire may only be replaced by the manufacturer or a service technician commissioned by him or a similarly qualified person.
Rated life time L70/B50 at 25 °C	50,000 h

Mounting technology	
Mounting method	Suspended
Place of installation	Ceiling-mounted
Adjustability	Not adjustable
Pendulum length min.	1,000 mm
Pendulum length max.	5,000 mm
Pendant length single suspension	1000 - 5000 mm
Pendulum length centre canopy	1000 - 5000 mm
Number of cable suspensions	4
Material cover	Plastic, opal
Suitable for through-wiring	No

Packing data	
Gross weight	10 kg
Length of packaging	1,230 mm
Packaging width	1,230 mm
Packaging height	90 mm
Disposal at end of life	This product must not be disposed of with household waste. You are obliged, to dispose of such electrical waste separately. By disposing of electrical waste and other old or defective electronics separately, you support recycling or other forms of re-use. In that way you help to take care and to avoid that harmful substances get into the environment.