

mobile combination units compact - rubber - Mobile combination units compact - solid rubber



Product description	
BALS-Prd.-Nr	53525
EAN	4024941194235
Product category	Distributor, solid rubber
Specification/Norm	DIN EN 61439-2
Protection degree	IP44
Colour of appliance	Housing bottom similar black RAL 9017, Housing top similar black RAL 9017
Height	88mm
Width	365mm

Product description	
Depth	120mm
RDF factor	1
Rated current InA	32

Logistics data	
Weight/pcs	4.362 kg / Piece
Packaging	Carton
Content amount	1 ST
EAN	4024941194235
Length	560 mm
Width	215 mm
Height	260 mm
Weight	4.824 kg
Volume	26,400 ccm

Metal surcharges	
Surcharge type	Kupfer
Materialbase	150 EUR per 100 Kilogram
Included weight of material	0.24 Kilogram per 1 Piece

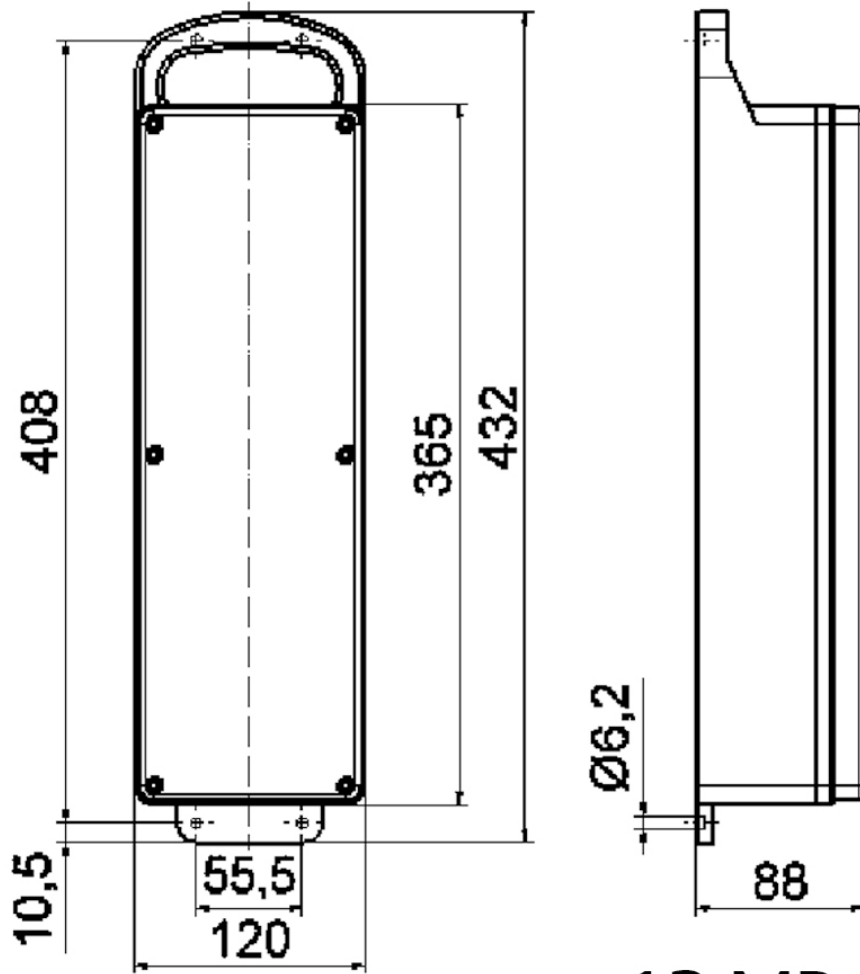

13 MB 7