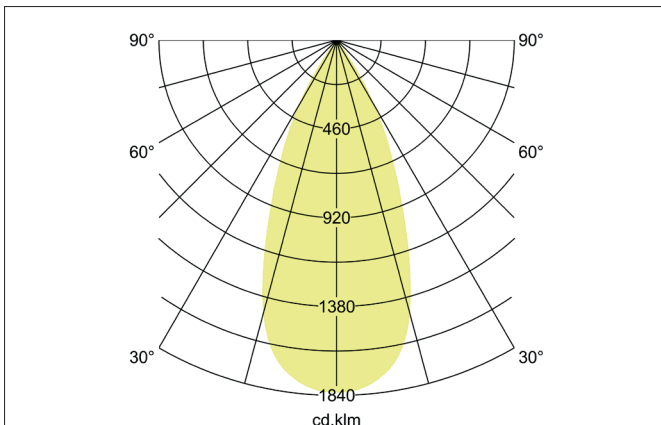
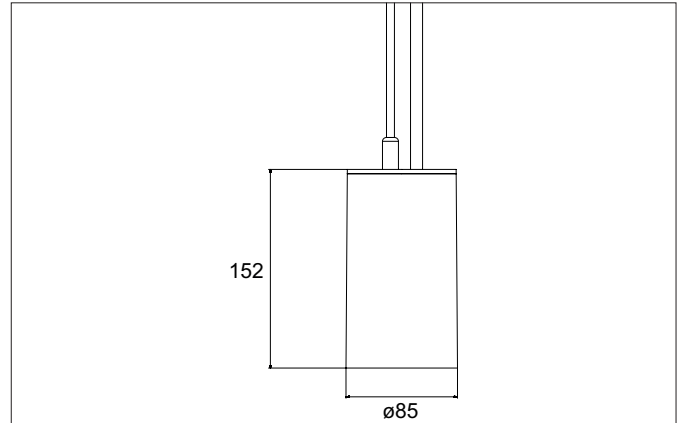

TRAXX MAXI LED pendant luminaire, on/off switchable

Article no. 88884163

Light.
For Generations.**Tender**

LED pendant luminaire, on/off switchable, Round., Hight 163.0 mm, for pendulum mounting. Pendulum length max. 1500.0 mm Weight 0.914 kg, with rotationssymmetrical, deep, wide distributed light intensity. optimal light distribution due to a glass transparent cover. Luminous flux 3.710 lm, Power 1 x 28 W, Light colour warm white, Correlated color temprature (CCT) 3.000 K, Colour rendering index CRI > 90, Rated life time L80/B50 at 25 °C: 50.000 h, Housing material: Aluminium / Glass / Plastic, Colour: Silver structure, Permissible ambient temperature (ta): -20 °C - +25 °C, Protection class (EN 61140): I, Degree of protection (DIN EN 60529): IP20, .With electronic driver, on/off switchable.

Article data	
Article no.	88884163
GTIN	4251433975861
Series name	TRAXX MAXI
Short description	LED pendant luminaire, on/off switchable
Material	Aluminium / Glass / Plastic
Colour	Silver
Type of surface	Structure
Shape	Round
Hight	163 mm
Weight	0.914 kg

TRAXX MAXI LED pendant luminaire, on/off switchable

Article no. 88884163

Light.
For Generations.

Lighting technology	
Colour temperature	3.000 K
Light colour	White
Light output	Direct
Luminous flux	3,710 lm
System efficiency	132 lm/W
McAdam-Step	McAdam-Step 3
Colour rendering	CRI > 90
Reflector	High-gloss
Beam angle	40°
Light sharing	Symmetric
Adjustable color temperature	No

Operating technology of the luminaire	
System output	28 W
Voltage type	AC
AC nominal voltage max	230 V
Frequenz max.	50 Hz
Lamp	LED
Lamp holder	Without fitting
Protection class	I
Degree of protection	IP20
Control	on/off
Bulb change possible	The light source of this luminaire may only be replaced by the manufacturer or a service technician commissioned by him or a similarly qualified person.
Rated life time L80/B50 at 25 °C	50.000 h

Mounting technology	
Mounting method	Suspended
Place of installation	Ceiling-mounted
Adjustability	Not adjustable
stamp	UKCA
Pendulum length max.	1,500 mm
Material cover	Glass transparent
Suitable for through-wiring	No

Packing data	
Gross weight	0.98 kg
Length of packaging	170 mm
Packaging width	170 mm
Packaging height	110 mm
Disposal at end of life	This product must not be disposed of with household waste. You are obliged, to dispose of such electrical waste separately. By disposing of electrical waste and other old or defective electronics separately, you support recycling or other forms of re-use. In that way you help to take care and to avoid that harmful substances get into the environment.