

panel mounting appliance inlet, straight - flange 85x85,
fixing centers 70x70

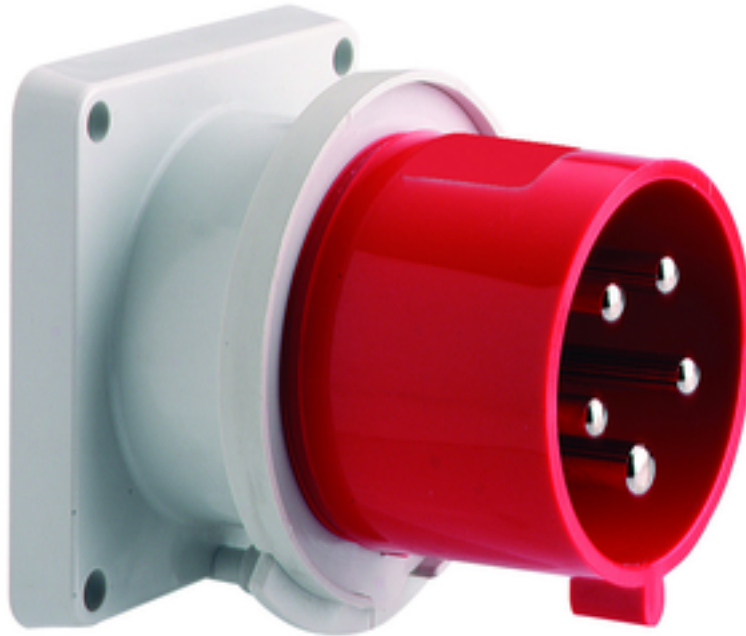

Product description	
BALS-Prd.-Nr	28108
EAN	4024941281089
Product category	Panel mounting appliance inlet, straight
Current	32A
Number of poles	5p
Arrangement of phases	3p+N+PE
Position of earth contact	6 h
Voltage	200/346 - 240/415V~

Product description	
Frequency	50/60Hz
Protection degree	IP44
Colour code	red RAL 3000
Colour of appliance	Enclosure grey RAL 7035, Collar red RAL 3000
Connection design	with screw terminal
Maximum conductor size	6,0 qmm
Cable entry	other
Height	88mm
Width	85mm
Depth	86mm
Flange size vertical in mm	85mm
Flange size horizontal in mm	85mm
Drill hole dist. vertical mm	70mm
Drill hole dist. horizontal mm	70mm
Material of enclosure	Polyamide
Contacts	The contact carrier is made of polyamide, The contacts are brass

Additional technical properties	
	A retaining device to match the hinged cover of the connector must be provided to ensure the latching feature

Logistics data	
Weight/pcs	0.24 kg / Piece
Packaging	Bag
Content amount	1 ST
EAN	4024941281089
Length	86 mm
Width	85 mm
Height	88 mm
Weight	0.241 kg
Volume	643.28 ccm
Packaging	Carton
Content amount	10 ST
EAN	4024941940498
Length	258 mm
Width	183 mm
Height	212 mm
Weight	2.552 kg
Volume	8,750 ccm

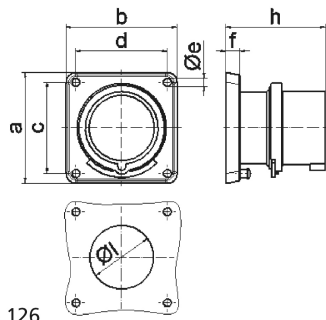

5 MB 126

Ampere	16	16	16	32	32	32
Polzahl	3	4	5	3	4	5
a	85,0	85,0	85,0	85,0	85,0	85,0
b	85,0	85,0	85,0	85,0	85,0	85,0
c	70,0	70,0	70,0	70,0	70,0	70,0
d	70,0	70,0	70,0	70,0	70,0	70,0
e ø	6,3	6,3	6,3	6,3	6,3	6,3
f	11,0	11,0	11,0	11,0	11,0	11,0
h	75,5	75,0	76,5	85,0	85,0	85,0
l ø	49,0	49,0	49,0	49,0	49,0	49,0
Leiter mm ² min	1	1	1	2,5	2,5	2,5
Leiter mm ² max	2,5	2,5	2,5	6	6	6