

FLIR 200.2030.50/DALI

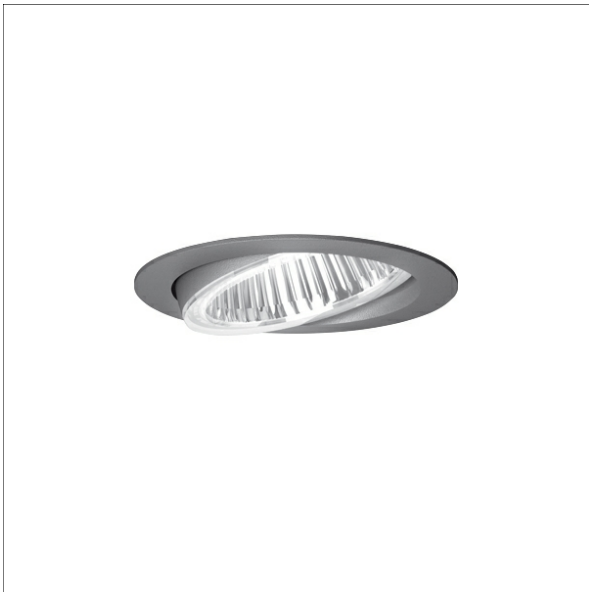

Farbe	Artikelnummer	EAN
schwarz	641756	4043544473028
silber	641757	4043544473035
weiß	641758	4043544473042

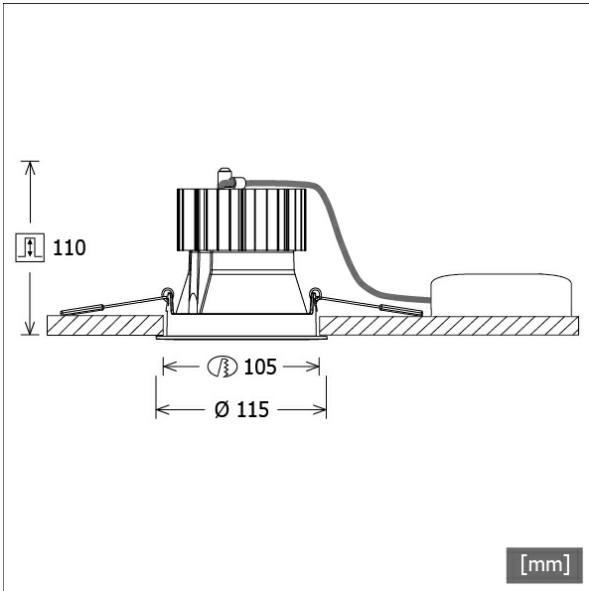

Beschreibung

- Einbaustrahler mit optischen Designvarianten und breitem Anwendungsspektrum
- Lichtkopf 20° schwenkbar
- hohe Wartungsfreundlichkeit
- keine UV- und Wärmestrahlung
- Wärmemanagement mit Passivkühlung (Kühlkörper aus Aluminium)
- High-Performance Spiegelreflektor aus Aluminium mit präziser symmetrischer Abstrahlcharakteristik für maximale Lichtausbeute und optimale Entblendung
- Front-/Einbauring aus Zinkdruckguss mit Lichteffektring klar (weitere Dekor-/Lichteffektringe und Dekogläser sind als Option erhältlich)
- werkzeugloser Deckeneinbau mit Schnellspannfedern (automatische Anpassung der Deckenstärke)
- Anschluss an Betriebsgerät über Leuchtenkabel mit Mini-Clamp Steckverbindung
- Betriebsgerät (LED-Konverter DALI, dimmbar) inklusive (Platzierung extern)

Standardoptionen

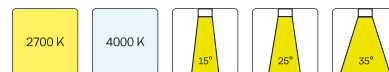

Sonderoptionen



Lichttechnik / Normen

Leuchtmittel	LED Spot / CRI 80 / 3000 K
EPREL Lichtquellen	848117
Lebensdauer	L90 B50 50.000 h
	L80 B50 100.000 h
	L80 B20 50.000 h
Systemleistung	27,0 W
Leuchten-Lichtstrom	max. 2880 lm
Systemeffizienz	106,66 lm/W
Moduleffizienz	156,64 lm/W
UGR Klasse	≤28
Abstrahlwinkel	50°
Versorgungsspannung	220 - 240 V / 50 - 60 Hz
Schutzklasse	III
Schutzart	IP20

Abmessungen / Gewichte

Außendurchmesser	115 mm
Höhe	112 mm
Ausschnittsmaß (Ø)	105 mm
Deckenstärke	1,0 - 25,0 mm
Einbautiefe	110 mm
Nettogewicht	0,93 kg
Bruttogewicht	1,01 kg

FLIR 200.2030.50/DALI

Flixx 200 Round (FLIRZ 200.05, 1xLED 27W 830/3000K 2880lm 50 °)

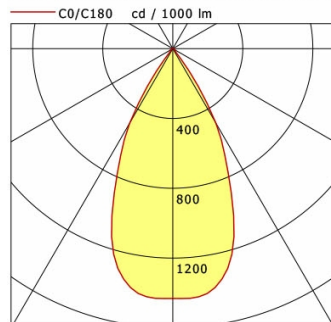

	C0	C90	C180	C270
0°	1431	1431	1431	1431
15°	1264	1264	1264	1264
30°	492	492	492	492
45°	17	17	17	17
60°	14	14	14	14
75°	6	6	6	6
90°	0	0	0	0

cd / 1000 lm

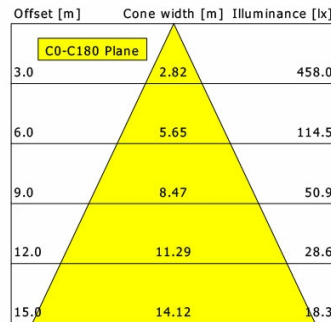

η	LED
Efficiency	107 lm/W
Direct/Indirect	↓ 100% / ↑ 0%
System Power	27 W
UGR	X=4H, Y=8H
Reflection factors	70/50/20
UGR C0/C180	21.4
UGR C90/C270	21.4
CIE Flux Codes	95 98 100 100 100
Ra/CRI	>80

LTS

Flixx 200 Round (FLIRZ 200.24, 1xLED 27W 830/3000K 2710lm 50 °)

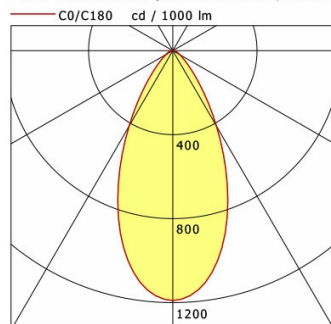

	C0	C90	C180	C270
0°	1190	1190	1190	1190
15°	936	936	936	936
30°	415	415	415	415
45°	116	116	116	116
60°	39	39	39	39
75°	16	16	16	16
90°	0	0	0	0

cd / 1000 lm

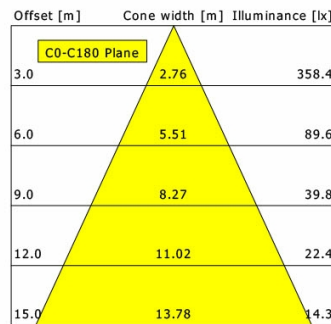

η	LED
Efficiency	100 lm/W
Direct/Indirect	↓ 100% / ↑ 0%
System Power	27 W
UGR	X=4H, Y=8H
Reflection factors	70/50/20
UGR C0/C180	26.4
UGR C90/C270	26.4
CIE Flux Codes	83 95 99 100 100
Ra/CRI	>80

LTS

Flixx 200 Round (FLIRZ 200.25, 1xLED 27W 830/3000K 2800lm 50 °)

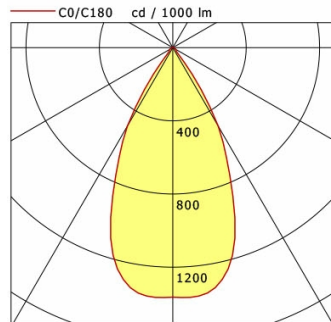

	C0	C90	C180	C270
0°	1364	1364	1364	1364
15°	1216	1216	1216	1216
30°	494	494	494	494
45°	27	27	27	27
60°	17	17	17	17
75°	6	6	6	6
90°	0	0	0	0

cd / 1000 lm

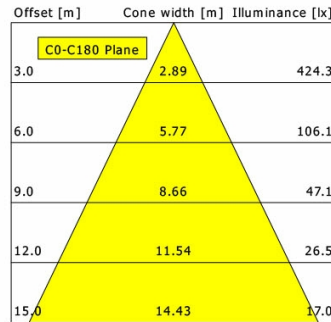

η	LED
Efficiency	104 lm/W
Direct/Indirect	↓ 100% / ↑ 0%
System Power	27 W
UGR	X=4H, Y=8H
Reflection factors	70/50/20
UGR C0/C180	21.6
UGR C90/C270	21.6
CIE Flux Codes	94 98 100 100 100
Ra/CRI	>80

LTS

FLIRZ 200.2030.50/DALI

Zubehör



FLIRZ 200.01
Dekorring schwarz



FLIRZ 200.02
Dekorring silber



FLIRZ 200.03
Dekorring weiß



FLIRZ 200.04
Lichteffektring opal



FLIRZ 200.05
Lichteffektring klar



FLIRZ 200.06
Lichteffektring rot matt



FLIRZ 200.07
Lichteffektring gelb matt



FLIRZ 200.08
Lichteffektring blau matt



FLIRZ 200.16
Lichteffektring rot transluzent



FLIRZ 200.17
Lichteffektring gelb transluzent



FLIRZ 200.18
Lichteffektring blau transluzent

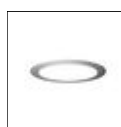

FLIRZ 200.24
Dekoglas opal



FLIRZ 200.25
Dekoglas klar