

# FLIR 100.1030.35/DALI

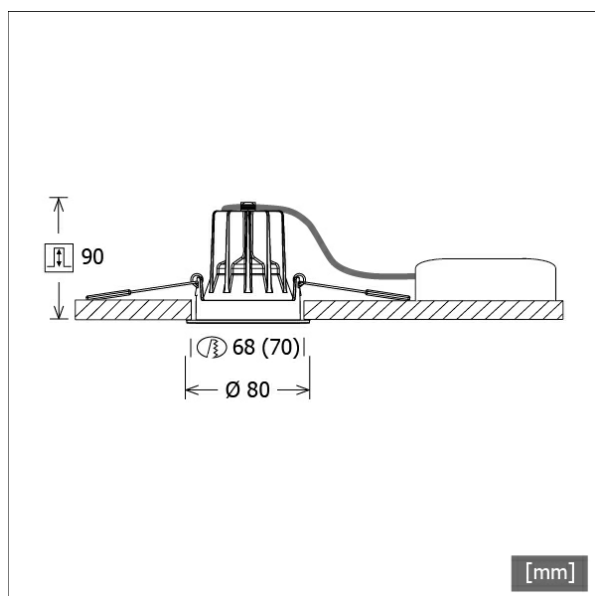

Farbe	Artikelnummer	EAN
schwarz	641723	4043544472694
silber	641724	4043544472700
weiß	641725	4043544472717



## Beschreibung

- Einbaustrahler mit optischen Designvarianten und breitem Anwendungsspektrum
- Lichtkopf 20° schwenkbar
- hohe Wartungsfreundlichkeit
- keine UV- und Wärmestrahlung
- innovatives Wärmemanagement mit Passivkühlung (Kühlkörper aus Aluminiumdruckguss)
- High-Performance Spiegelreflektor aus Aluminium mit präziser symmetrischer Abstrahlcharakteristik für maximale Lichtausbeute und optimale Entblendung
- Front-/Einbauring aus Zinkdruckguss mit Lichteffektring klar (weitere Dekor-/Lichteffektringe und Dekogläser sind als Option erhältlich)
- werkzeugloser Deckeneinbau mit Schnellspannfedern (automatische Anpassung der Deckenstärke)
- Anschluss an Betriebsgerät über Leuchtenkabel mit Mini-Clamp Steckverbindung
- Betriebsgerät (LED-Konverter DALI, dimmbar) inklusive (Platzierung extern)

## Hinweise

Das Aussägemeaß = 68 mm gilt nur für Gipskartondecken. Für andere Deckenarten gilt das Aussägemeaß = 70 mm.

## Standardoptionen

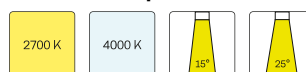

## Sonderoptionen

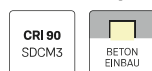

## Lichttechnik / Normen

Leuchtmittel	LED Spot / CRI 80 / 3000 K
EPREL Lichtquellen	988880
Lebensdauer	L90 B50 50.000 h L80 B50 100.000 h L80 B20 50.000 h
Systemleistung	15.0 W
Leuchten-Lichtstrom	max. 1360 lm
Systemeffizienz	84.66 lm/W
Moduleffizienz	134.38 lm/W
UGR Klasse	≤28
Abstrahlwinkel	35°
Versorgungsspannung	220 - 240 V / 50 - 60 Hz
Schutzklasse	III
Schutzart	IP20

## Abmessungen / Gewichte

Außendurchmesser	80 mm
Höhe	92 mm
Ausschnittsmaß (Ø)	68 mm
Deckenstärke	1.0 - 25.0 mm
Einbautiefe	90 mm
Nettogewicht	0.48 kg

Einbau-Downlights · Flixx 100 Round

FLIR 100.1030.35/DALI

Bruttogewicht



LTS  
LOVE TO SHINE

0.50 kg

# FLIR 100.1030.35/DALI

Flixx 100 Round (FLIRZ 100.24, 1xLED 15W 830/3000K 1270lm 35 °)

C0/C180 cd / 1000 lm

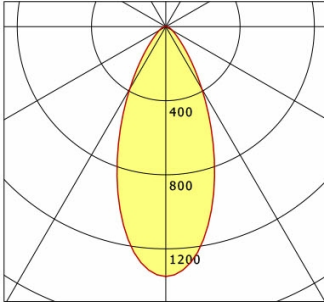

	C0	C90	C180	C270
0°	1350	1350	1350	1350
15°	977	977	977	977
30°	389	389	389	389
45°	109	109	109	109
60°	41	41	41	41
75°	17	17	17	17
90°	0	0	0	0
cd / 1000 lm				

Offset [m] Cone width [m] Illuminance [lx]

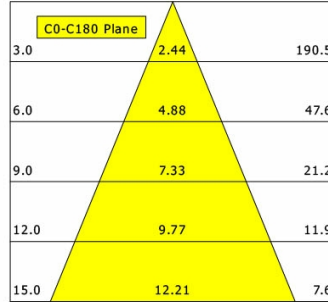

<b>η</b>	LED
Efficiency	85 lm/W
Direct/Indirect	↓ 100% / ↑ 0%
System Power	15 W
<b>UGR</b>	X=4H, Y=8H
Reflection factors	70/50/20
UGR C0/C180	26.9
UGR C90/C270	26.9
CIE Flux Codes	82 94 99 100 100
Ra/CRI	>80

LTS

Flixx 100 Round (FLIRZ 100.05, 1xLED 15W 830/3000K 1360lm 35 °)

C0/C180 cd / 1000 lm

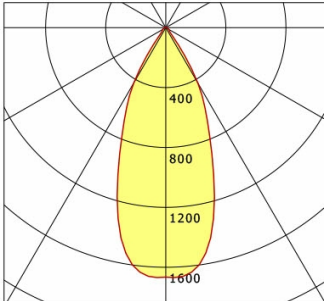

	C0	C90	C180	C270
0°	1666	1666	1666	1666
15°	1246	1246	1246	1246
30°	426	426	426	426
45°	36	36	36	36
60°	23	23	23	23
75°	12	12	12	12
90°	1	1	1	1
cd / 1000 lm				

Offset [m] Cone width [m] Illuminance [lx]

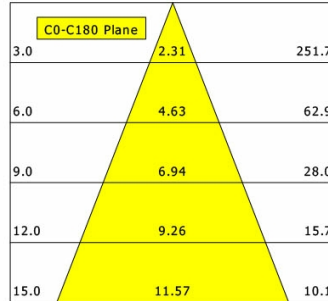

<b>η</b>	LED
Efficiency	91 lm/W
Direct/Indirect	↓ 100% / ↑ 0%
System Power	15 W
<b>UGR</b>	X=4H, Y=8H
Reflection factors	70/50/20
UGR C0/C180	24.4
UGR C90/C270	24.4
CIE Flux Codes	91 96 99 100 100
Ra/CRI	>80

LTS

Flixx 100 Round (FLIRZ 100.25, 1xLED 15W 830/3000K 1310lm 35 °)

C0/C180 cd / 1000 lm

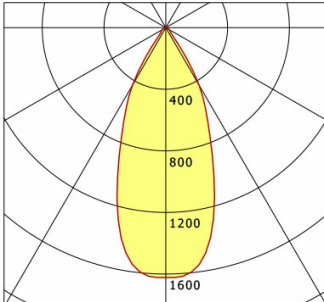

	C0	C90	C180	C270
0°	1622	1622	1622	1622
15°	1213	1213	1213	1213
30°	432	432	432	432
45°	46	46	46	46
60°	26	26	26	26
75°	9	9	9	9
90°	0	0	0	0
cd / 1000 lm				

Offset [m] Cone width [m] Illuminance [lx]

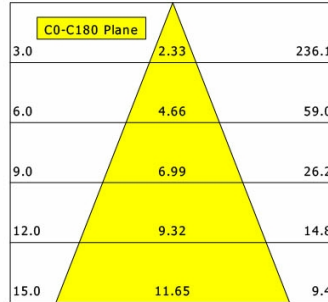

<b>η</b>	LED
Efficiency	87 lm/W
Direct/Indirect	↓ 100% / ↑ 0%
System Power	15 W
<b>UGR</b>	X=4H, Y=8H
Reflection factors	70/50/20
UGR C0/C180	23.5
UGR C90/C270	23.5
CIE Flux Codes	91 97 99 100 100
Ra/CRI	>80

LTS

# FLIR 100.1030.35/DALI

## Zubehör



**FLIRZ 100.01**  
Dekorring schwarz



**FLIRZ 100.02**  
Dekorring silber



**FLIRZ 100.03**  
Dekorring weiß



**FLIRZ 100.04**  
Lichteffektring opal



**FLIRZ 100.05**  
Lichteffektring klar



**FLIRZ 100.06**  
Lichteffektring rot matt



**FLIRZ 100.07**  
Lichteffektring gelb matt



**FLIRZ 100.08**  
Lichteffektring blau matt



**FLIRZ 100.16**  
Lichteffektring rot transluzent



**FLIRZ 100.17**  
Lichteffektring gelb transluzent



**FLIRZ 100.18**  
Lichteffektring blau transluzent

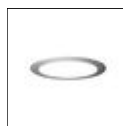

**FLIRZ 100.24**  
Dekoglas opal



**FLIRZ 100.25**  
Dekoglas klar