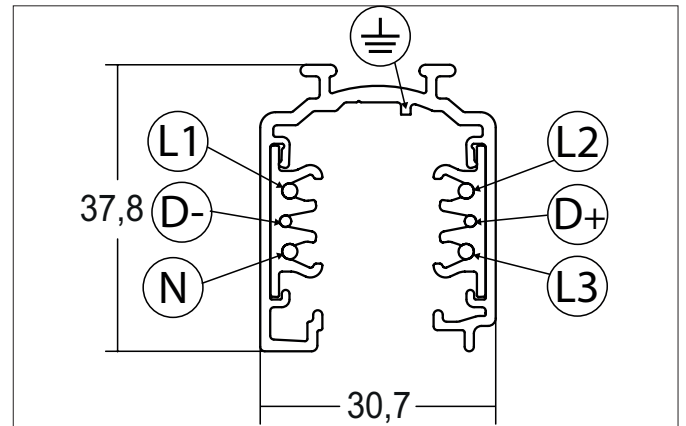
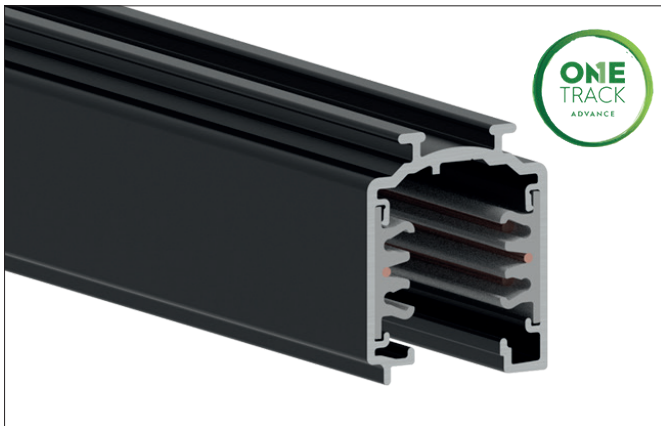

3-phase track

Article no. 87161070

Light.
For Generations.

230V

Tender

3-phase track, white, Rectangular. Surface mounting Mounting method: Surface mounting, Material: Aluminium, Degree of protection: according to DIN EN 60529 IP20, Protection class: (EN 61140) I, Voltage: 230V AC 50Hz, .

Article data	
Article no.	87161070
GTIN	4251433979821
Short description	3-phase track
Material	Aluminium
Colour	White
Type of surface	Glossy
Shape	Rectangular
Length	1,000 mm
Width	36 mm
Hight	33 mm
Weight	0.850 kg

3-phase track

Article no. 87161070

Light.
For Generations.

Packing data	
Gross weight	1.11 kg
Length of packaging	1,070 mm
Packaging width	55 mm
Packaging height	55 mm
Disposal at end of life	<p>This product must not be disposed of with household waste. You are obliged, to dispose of such electrical waste separately.</p> <p>By disposing of electrical waste and other old or defective electronics separately, you support recycling or other forms of re-use. In that way you help to take care and to avoid that harmful substances get into the environment.</p>