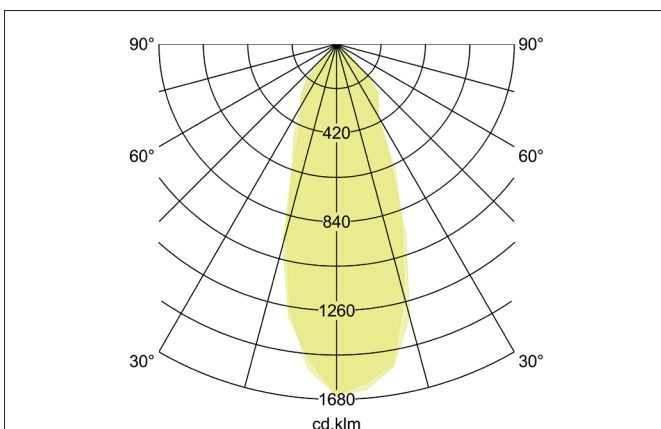
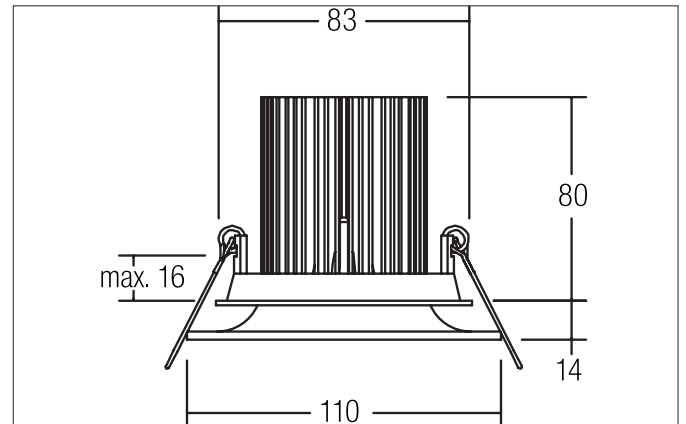

**CARESA LED recessed downlight, with indirect light component**

Article no. 12406073

Light.  
For Generations.**Tender**

LED recessed downlight, with indirect light component, Round. Toolless ceiling installation by installation springs. Ceiling cut-out  $\varnothing$  83 mm, Installation depth 80 mm, Outer diameter 110 mm, Weight 0,323 kg. Reflector silver with rotationssymmetrical, deep, wide distributed light intensity. optimal light distribution due to a plastic, transparent cover. Luminous flux 887 lm, Power 1 x 10,5 W, Light colour warm white, Correlated color temprature (CCT) 3.000 K, Colour rendering index CRI > 80, Rated life time L70/B50 at 25 °C: 50.000 h, Housing material: Aluminium / Glass, Colour: White, Permissible ambient temperature (ta): -20 °C - +25 °C, Protection class (EN 61140): III, Degree of protection (DIN EN 60529): IP20, .For connection to an external driver, which is not included in the scope of delivery of the luminaire. Depending on driver dimmable.

**Product Benefits**

- Recessed downlight in round design made of massive aluminum.
- Ceiling cutout 83 mm, outer diameter 110 mm, mounting depth 48 mm, Height 14 mm, luminous flux 887 lm, IP20.
- Recessed, indirect light for ceiling brightening.
- Dimmable when using a suitable converter.
- Also available as a factory complete set with dimmable converter (trailing-edge phase dimmer).

**CARESA LED recessed downlight, with indirect light component**

Article no. 12406073

Light.  
For Generations.

Article data	
Article no.	12406073
GTIN	4250047781264
Series name	CARESA
Short description	LED recessed downlight, with indirect light component
Material	Aluminium / Glass
Colour	White
Type of surface	Matt
Shape	Round
Outer diameter	110 mm
Built-in diameter	83 mm
Installation depth	80 mm
Hight	14 mm
Weight	0.323 kg
stamp	UKCA

Lighting technology	
Colour temperature	3.000 K
Light colour	White
Light output	Direct/Indirect
Luminous flux	887 lm
System efficiency	84 lm/W
Colour rendering	CRI > 80
Reflector	High-gloss
Reflector colour	silver
Beam angle	34°
Light sharing	Symmetric
Adjustable color temperature	No

Operating technology of the luminaire	
Voltage type	DC
Current	350 mA
Lamp	LED
Protection class	III
Degree of protection	IP20
Dimmable	Depending on type of control gear
Control	Depending on driver
Bulb change possible	The light source of this luminaire may only be replaced by the manufacturer or a service technician commissioned by him or a similarly qualified person.
Rated life time L70/B50 at 25 °C	50,000 h

Mounting technology	
Mounting method	Recessed mounting
Place of installation	Ceiling-mounted
Adjustability	Not adjustable
Max. ceiling thickness	16 mm
Further references	No cover with thermal insulation material
Material cover	Plastic, transparent
Suitable for through-wiring	Yes, with optional accessories

**CARESA LED recessed downlight, with indirect light component**

Article no. 12406073











Light.  
For Generations.

Packing data	
Gross weight	0.439 kg
Length of packaging	145 mm
Packaging width	145 mm
Packaging height	140 mm
Disposal at end of life	<p>This product must not be disposed of with household waste. You are obliged, to dispose of such electrical waste separately.</p> <p>By disposing of electrical waste and other old or defective electronics separately, you support recycling or other forms of re-use. In that way you help to take care and to avoid that harmful substances get into the environment.</p>

**CARESA LED recessed downlight, with indirect light component**

Article no. 12406073

Light.  
For Generations.

Accessories	
	Article no.: 17613000 LED converter 350 mA, on/off switchable Power: 1 - 15 W Dimensions: 115 mm x 34 mm x 19 mm
	Article no.: 17613010 LED converter 350 mA, on/off switchable Power: 1 - 15 W Dimensions: 115 mm x 34 mm x 19 mm
	Article no.: 17613020 LED converter 350 mA, on/off switchable Power: 1 - 15 W Dimensions: 115 mm x 34 mm x 19 mm
	Article no.: 17621000 LED converter 350 mA, on/off switchable Power: 1 - 21 W Dimensions: 128 mm x 50 mm x 13 mm
	Article no.: 17621010 LED converter 350 mA, on/off switchable Power: 1 - 21 W Dimensions: 128 mm x 50 mm x 13 mm
	Article no.: 17621020 LED converter 350 mA, on/off switchable Power: 1 - 21 W Dimensions: 128 mm x 50 mm x 13 mm
	Article no.: 17664000 LED converter 350 mA, trailing-edge phase dimmable Power: 10,2 - 14 W Dimensions: 125 mm x 51 mm x 20 mm
	Article no.: 17664010 LED converter 350 mA, trailing-edge phase dimmable Power: 10,2 - 14 W Dimensions: 125 mm x 51 mm x 20 mm
	Article no.: 17664020 LED converter 350 mA, trailing-edge phase dimmable Power: 10,2 - 14 W Dimensions: 125 mm x 51 mm x 20 mm
	Article no.: 17643000 LED converter 350 mA, trailing-edge phase dimmable Power: 8,8 - 18 W Dimensions: 110 mm x 52 mm x 22 mm

**CARESA LED recessed downlight, with indirect light component**

Article no. 12406073



Light.  
For Generations.

Accessories	
	Article no.: 17643010 LED converter 350 mA, trailing-edge phase dimmable Power: 8,8 - 18 W Dimensions: 110 mm x 52 mm x 22 mm
	Article no.: 17643020 LED converter 350 mA, trailing-edge phase dimmable Power: 8,8 - 18 W Dimensions: 110 mm x 52 mm x 22 mm
	Article no.: 17648000 LED converter 350 mA, trailing-edge phase dimmable Power: 0,7 - 17 W Dimensions: 166 mm x 46 mm x 34 mm
	Article no.: 17648010 LED converter 350 mA, trailing-edge phase dimmable Power: 0,7 - 17 W Dimensions: 166 mm x 46 mm x 34 mm
	Article no.: 17648020 LED converter 350 mA, trailing-edge phase dimmable Power: 0,7 - 17 W Dimensions: 166 mm x 46 mm x 34 mm
	Article no.: 17657000 LED converter 350 mA, 1-10 V dimmable (analog) Power: 5,2 - 18 W Dimensions: 110 mm x 52 mm x 22 mm
	Article no.: 17657010 LED converter 350 mA, 1-10 V dimmable (analog) Power: 5,2 - 18 W Dimensions: 110 mm x 52 mm x 22 mm
	Article no.: 17683000 LED converter 350 mA, DALI dimmable (digital) Power: 3,5 - 17 W Dimensions: 110 mm x 52 mm x 22 mm
	Article no.: 17683010 LED converter 350 mA, DALI dimmable (digital) Power: 3,5 - 17 W Dimensions: 110 mm x 52 mm x 22 mm
	Article no.: 17683020 LED converter 350 mA, DALI dimmable (digital) Power: 3,5 - 17 W Dimensions: 110 mm x 52 mm x 22 mm
	Article no.: 17671000 LED converter 350mA, ZigBee dimmable Power: 3,5 - 18,5 W Dimensions: 146 mm x 44 mm x 30 mm

**CARESA LED recessed downlight, with indirect light component**

Article no. 12406073

Light.  
For Generations.

Accessories	
	<p>Article no.: 17671010 LED converter 350mA, ZigBee dimmable Power: 3,5 - 18,5 W Dimensions: 146 mm x 44 mm x 30 mm</p>
	<p>Article no.: 17671020 LED converter 350mA, ZigBee dimmable Power: 3,5 - 18,5 W Dimensions: 146 mm x 44 mm x 30 mm</p>
	<p>Article no.: 17672000 LED converter 350mA, Casambi dimmable Power: 3,5 - 18 W Dimensions: 146 mm x 44 mm x 30 mm</p>
	<p>Article no.: 17672010 LED converter 350mA, Casambi dimmable Power: 3,5 - 18 W Dimensions: 146 mm x 44 mm x 30 mm</p>
	<p>Article no.: 17672020 LED converter 350mA, Casambi dimmable Power: 3,5 - 18 W Dimensions: 146 mm x 44 mm x 30 mm</p>
	<p>Article no.: 17682000 LED converter 350 mA, DALI dimmable (digital) Power: 1,8 - 18,5 W Dimensions: 146 mm x 43.5 mm x 22 mm</p>
	<p>Article no.: 17682010 LED converter 350 mA, DALI dimmable (digital) Power: 1,8 - 18,5 W Dimensions: 146 mm x 43.5 mm x 22 mm</p>
	<p>Article no.: 17682020 LED converter 350 mA, DALI dimmable (digital) Power: 1,8 - 18,5 W Dimensions: 146 mm x 43.5 mm x 22 mm</p>
	<p>Article no.: 3835 Plug &amp; Play extension lead 350 mA Dimensions: 500 mm</p>
	<p>Article no.: 3836 Plug &amp; Play extension lead 350 mA Dimensions: 1,000 mm</p>
	<p>Article no.: 3837 Plug &amp; Play extension lead 350 mA Dimensions: 2,000 mm</p>