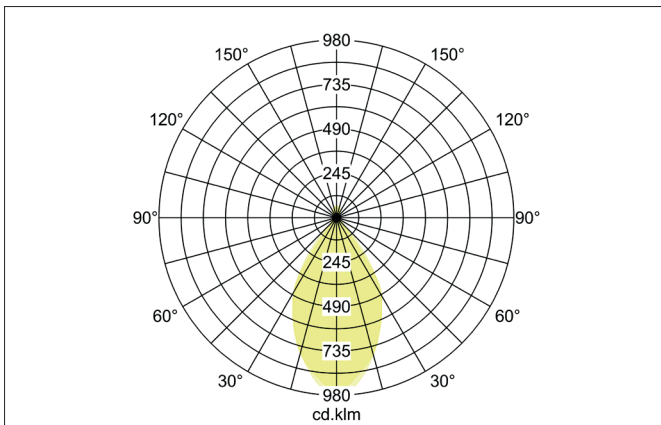
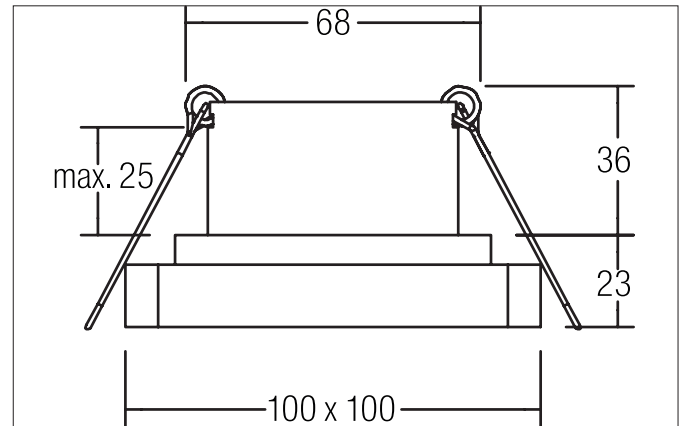

QUBIC LED recessed downlight, with indirect light component

Article no. 12227183

Light.
For Generations.**Tender**

LED recessed downlight, with indirect light component, Square. Toolless ceiling installation by installation springs. Ceiling cut-out \varnothing 68 mm, Installation depth 36 mm, Length 100 mm, Width 100 mm, Weight 0,410 kg, Reflector silver with rotationssymmetrical, deep, wide distributed light intensity. optimal light distribution due to a polycarbonat clear cover. Luminous flux 800 lm, Power 1 x 11 W, System Efficiency 73 lm/W, Light colour warm white, Correlated color temprature (CCT) 3.000 K, Colour rendering index CRI > 90, Rated life time L70/B50 at 25 °C: 50.000 h, Housing material: Aluminium / Polycarbonate, Colour: Black structure, Permissible ambient temperature (ta): -20 °C - +25 °C, Protection class (EN 61140): III, Degree of protection (DIN EN 60529): IP20, .For connection to an external driver, which is not included in the scope of delivery of the luminaire. Depending on driver dimmable.

Product Benefits

- Square recessed downlight made of massive aluminum with indirect light component.
- Easy and tool-free installation.
- CRI > 80.
- Dimmable when using appropriate converters.
- Low installation depth of 36 mm - Length 100 mm x width 100 mm, ceiling cut-out 68 mm.
- Ceiling thickness max. 22 mm.
- Part of the QUBIC product family.
- Available in white structure and black structure.

QUBIC LED recessed downlight, with indirect light component

Article no. 12227183

Light.
For Generations.

Article data	
Article no.	12227183
GTIN	4251433953371
Series name	QUBIC
Short description	LED recessed downlight, with indirect light component
Material	Aluminium / Polycarbonate
Colour	Black
Type of surface	Structure
Shape	Square
Built-in diameter	68 mm
Installation depth	36 mm
Length	100 mm
Width	100 mm
Hight	23 mm
Weight	0.410 kg
stamp	UKCA

Lighting technology	
Colour temperature	3.000 K
Light colour	White
Light output	Direct/Indirect
Luminous flux	800 lm
System efficiency	73 lm/W
Colour rendering	CRI > 90
Reflector	High-gloss
Reflector colour	silver
Beam angle	57°
Light sharing	Symmetric
Adjustable color temperature	No

Operating technology of the luminaire	
Voltage type	DC
Current	350 mA
Lamp	LED
Lamp holder	Plug&Play
Protection class	III
Degree of protection	IP20
Dimmable	Depending on type of control gear
Control	Depending on driver
Bulb change possible	The light source of this luminaire may only be replaced by the manufacturer or a service technician commissioned by him or a similarly qualified person.
Rated life time L70/B50 at 25 °C	50,000 h

Mounting technology	
Mounting method	Recessed mounting
Place of installation	Ceiling-mounted
Adjustability	Not adjustable
Max. ceiling thickness	25 mm
Further references	No cover with thermal insulation material
Material cover	Polycarbonat clear

QUBIC LED recessed downlight, with indirect light component

Article no. 12227183











Light.
For Generations.

Packing data	
Gross weight	0.47 kg
Length of packaging	150 mm
Packaging width	130 mm
Packaging height	70 mm
Disposal at end of life	<p>This product must not be disposed of with household waste. You are obliged, to dispose of such electrical waste separately.</p> <p>By disposing of electrical waste and other old or defective electronics separately, you support recycling or other forms of re-use. In that way you help to take care and to avoid that harmful substances get into the environment.</p>

QUBIC LED recessed downlight, with indirect light component

Article no. 12227183

Light.
For Generations.

Accessories	
	Article no.: 17613000 LED converter 350 mA, on/off switchable Power: 1 - 15 W Dimensions: 115 mm x 34 mm x 19 mm
	Article no.: 17613010 LED converter 350 mA, on/off switchable Power: 1 - 15 W Dimensions: 115 mm x 34 mm x 19 mm
	Article no.: 17613020 LED converter 350 mA, on/off switchable Power: 1 - 15 W Dimensions: 115 mm x 34 mm x 19 mm
	Article no.: 17621000 LED converter 350 mA, on/off switchable Power: 1 - 21 W Dimensions: 128 mm x 50 mm x 13 mm
	Article no.: 17621010 LED converter 350 mA, on/off switchable Power: 1 - 21 W Dimensions: 128 mm x 50 mm x 13 mm
	Article no.: 17621020 LED converter 350 mA, on/off switchable Power: 1 - 21 W Dimensions: 128 mm x 50 mm x 13 mm
	Article no.: 17664000 LED converter 350 mA, trailing-edge phase dimmable Power: 10,2 - 14 W Dimensions: 125 mm x 51 mm x 20 mm
	Article no.: 17664010 LED converter 350 mA, trailing-edge phase dimmable Power: 10,2 - 14 W Dimensions: 125 mm x 51 mm x 20 mm
	Article no.: 17664020 LED converter 350 mA, trailing-edge phase dimmable Power: 10,2 - 14 W Dimensions: 125 mm x 51 mm x 20 mm
	Article no.: 17643000 LED converter 350 mA, trailing-edge phase dimmable Power: 8,8 - 18 W Dimensions: 110 mm x 52 mm x 22 mm

QUBIC LED recessed downlight, with indirect light component

Article no. 12227183







Light.
For Generations.

Accessories	
	Article no.: 17643010 LED converter 350 mA, trailing-edge phase dimmable Power: 8,8 - 18 W Dimensions: 110 mm x 52 mm x 22 mm
	Article no.: 17643020 LED converter 350 mA, trailing-edge phase dimmable Power: 8,8 - 18 W Dimensions: 110 mm x 52 mm x 22 mm
	Article no.: 17648000 LED converter 350 mA, trailing-edge phase dimmable Power: 0,7 - 17 W Dimensions: 166 mm x 46 mm x 34 mm
	Article no.: 17648010 LED converter 350 mA, trailing-edge phase dimmable Power: 0,7 - 17 W Dimensions: 166 mm x 46 mm x 34 mm
	Article no.: 17648020 LED converter 350 mA, trailing-edge phase dimmable Power: 0,7 - 17 W Dimensions: 166 mm x 46 mm x 34 mm
	Article no.: 17657000 LED converter 350 mA, 1-10 V dimmable (analog) Power: 5,2 - 18 W Dimensions: 110 mm x 52 mm x 22 mm
	Article no.: 17657010 LED converter 350 mA, 1-10 V dimmable (analog) Power: 5,2 - 18 W Dimensions: 110 mm x 52 mm x 22 mm
	Article no.: 17683000 LED converter 350 mA, DALI dimmable (digital) Power: 3,5 - 17 W Dimensions: 110 mm x 52 mm x 22 mm
	Article no.: 17683010 LED converter 350 mA, DALI dimmable (digital) Power: 3,5 - 17 W Dimensions: 110 mm x 52 mm x 22 mm
	Article no.: 17683020 LED converter 350 mA, DALI dimmable (digital) Power: 3,5 - 17 W Dimensions: 110 mm x 52 mm x 22 mm
	Article no.: 17671000 LED converter 350mA, ZigBee dimmable Power: 3,5 - 18,5 W Dimensions: 146 mm x 44 mm x 30 mm

QUBIC LED recessed downlight, with indirect light component

Article no. 12227183

Light.
For Generations.

Accessories	
	<p>Article no.: 17671010 LED converter 350mA, ZigBee dimmable Power: 3,5 - 18,5 W Dimensions: 146 mm x 44 mm x 30 mm</p>
	<p>Article no.: 17671020 LED converter 350mA, ZigBee dimmable Power: 3,5 - 18,5 W Dimensions: 146 mm x 44 mm x 30 mm</p>
	<p>Article no.: 17672000 LED converter 350mA, Casambi dimmable Power: 3,5 - 18 W Dimensions: 146 mm x 44 mm x 30 mm</p>
	<p>Article no.: 17672010 LED converter 350mA, Casambi dimmable Power: 3,5 - 18 W Dimensions: 146 mm x 44 mm x 30 mm</p>
	<p>Article no.: 17672020 LED converter 350mA, Casambi dimmable Power: 3,5 - 18 W Dimensions: 146 mm x 44 mm x 30 mm</p>
	<p>Article no.: 17682000 LED converter 350 mA, DALI dimmable (digital) Power: 1,8 - 18,5 W Dimensions: 146 mm x 43.5 mm x 22 mm</p>
	<p>Article no.: 17682010 LED converter 350 mA, DALI dimmable (digital) Power: 1,8 - 18,5 W Dimensions: 146 mm x 43.5 mm x 22 mm</p>
	<p>Article no.: 17682020 LED converter 350 mA, DALI dimmable (digital) Power: 1,8 - 18,5 W Dimensions: 146 mm x 43.5 mm x 22 mm</p>
	<p>Article no.: 3835 Plug & Play extension lead 350 mA Dimensions: 500 mm</p>
	<p>Article no.: 3836 Plug & Play extension lead 350 mA Dimensions: 1,000 mm</p>
	<p>Article no.: 3837 Plug & Play extension lead 350 mA Dimensions: 2,000 mm</p>