

JAMIE 301.940.25.2/DALI-ST



Beschreibung

- flexibler Stromschienenstrahler in kompakter Bauform mit zylinderförmigem Design
- Leuchte 350° drehbar und 90° schwenkbar über integrierten Gelenkarm
- hohe Wartungsfreundlichkeit
- keine UV- und Wärmestrahlung
- Wärmemanagement über Gehäuse
- Spiegelreflektor aus Aluminium mit präziser symmetrischer Abstrahlcharakteristik für optimale Lichtausbeute und Entblendung
- Gehäusezylinder aus Aluminium
- Schutzglas klar
- 3-Phasen-Stromschienenadapter DALI (ONETrack)
- Betriebsgerät (LED-Konverter DALI, dimmbar) integriert

Standardoptionen

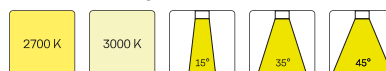

Farbe	Artikelnummer	EAN
silber	661954	4043544710017
schwarz	661955	4043544710024
weiß	661956	4043544710031

Sonderoptionen



Lichttechnik / Normen

Leuchtmittel	LED Spot / CRI 90 / 4000 K
EPREL Lichtquellen	851045
Lebensdauer	L90 B50 50.000 h L80 B50 100.000 h L80 B20 50.000 h
Systemleistung	16.0 W
Leuchten-Lichtstrom	1460 lm
Systemeffizienz	91.25 lm/W
Moduleffizienz	139.42 lm/W
UGR Klasse	≤19
Abstrahlwinkel	25°
Versorgungsspannung	220 - 240 V / 50 - 60 Hz
Schutzklasse	I
Schutzart	IP20

Abmessungen / Gewichte

Länge	108 mm
Breite	80 mm
Höhe	220 mm
Durchmesser Lichtkopf	80 mm
Nettogewicht	0.94 kg
Bruttogewicht	1.02 kg

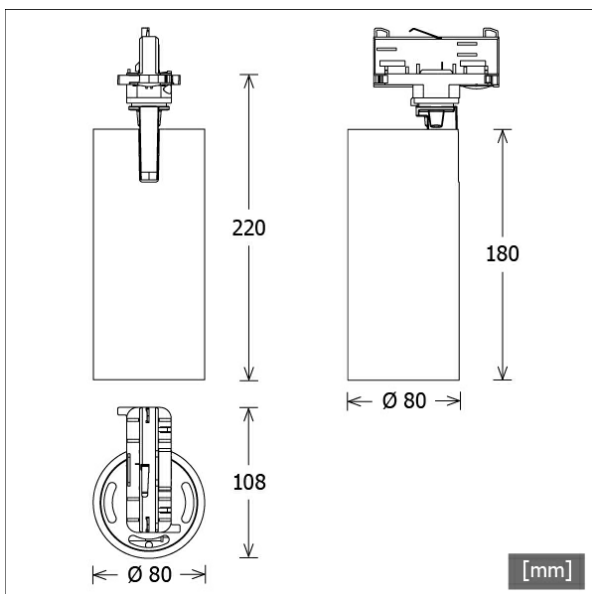

JAMIE 301.940.25.2/DALI-ST

Jamie 300 (1xLED 16W 940/4000K 1460lm 25 °)

C0/C180 cd / 1000 lm

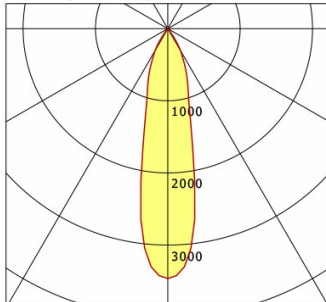

	C0	C90	C180	C270
0°	3464	3464	3464	3464
15°	1160	1160	1160	1160
30°	351	351	351	351
45°	17	17	17	17
60°	9	9	9	9
75°	5	5	5	5
90°	0	0	0	0

cd / 1000 lm

Offset [m] Cone width [m] Illuminance [lx]

Offset [m]	Cone width [m]	Illuminance [lx]
3.0	1.24	562.0
6.0	2.48	140.5
9.0	3.73	62.4
12.0	4.97	35.1
15.0	6.21	22.5

η	LED
Efficiency	91 lm/W
Direct/Indirect	↓ 100% / ↑ 0%
System Power	16 W
UGR	X=4H, Y=8H
Reflection factors	70/50/20
UGR C0/C180	17.8
UGR C90/C270	17.8
CIE Flux Codes	96 99 100 100 100
Ra/CRI	>90

LTS

Zubehör



ST-A 10/9000A-1-ST
Anbau-Stromschiene ONETrack Advance mit Datenbus
(Länge: 1000 mm)



ST-A 20/9000A-2-ST
Anbau-Stromschiene ONETrack Advance mit Datenbus
(Länge: 2000 mm)



ST-A 30/9000A-3-ST
Anbau-Stromschiene ONETrack Advance mit Datenbus
(Länge: 3000 mm)



ST-A 40/9000A-4-ST
Anbau-Stromschiene ONETrack Advance mit Datenbus
(Länge: 4000 mm)



ST-A MONO/9000-BPU-D
3-Phasen-Anbau-Monopoint mit Busoption



ST-E 10/9000-1-R
Einbau-Stromschiene ONETrack mit Datenbus
(Länge: 1000 mm)



ST-E 20/9000-2-R
Einbau-Stromschiene ONETrack mit Datenbus
(Länge: 2000 mm)



ST-E 30/9000-3-R
Einbau-Stromschiene ONETrack mit Datenbus
(Länge: 3000 mm)



ST-E 40/9000-4-R
Einbau-Stromschiene ONETrack mit Datenbus
(Länge: 4000 mm)



ST-E MONO/9000-BPU-D
3-Phasen-Einbau-Monopoint mit Busoption



ZBK 12
Blendklappe



ZBW 85
Wabenraster