

# SCOUT 202.940.35.2/DALI-ST



## Beschreibung

- flexibler Stromschienenstrahler in getrennter Bauform mit zylinderförmigem Lichtkopf
- Lichtkopf 355° drehbar und 90° schwenkbar über integrierten Gelenkarm
- hohe Wartungsfreundlichkeit
- keine UV- und Wärmestrahlung
- Lichtkopf aus Aluminiumdruckguss
- innovatives Wärmemanagement mit formintegrierter Passivkühlung
- High-Performance Spiegelreflektor aus Aluminium mit präziser symmetrischer Abstrahlcharakteristik für optimale Lichtausbeute und Entblendung
- Gehäuse für Betriebsgerät aus Aluminium
- reflektionsfreies EnergyVision Schutzglas klar
- 3-Phasen-Stromschienenadapter DALI (ONTrack)
- Betriebsgerät (LED-Konverter DALI, dimmbar) integriert

## Standardoptionen



Farbe	Artikelnummer	EAN
silber	662138	4043544711854
schwarz	662139	4043544711861
weiß	662140	4043544711878

## Sonderoptionen



## Lichttechnik / Normen

Leuchtmittel	LED Spot / CRI 90 / 4000 K
EPREL Lichtquellen	848115
Lebensdauer	L90 B50 50.000 h L80 B50 100.000 h L80 B20 50.000 h
Systemleistung	21.0 W
Leuchten-Lichtstrom	2430 lm
Systemeffizienz	115.71 lm/W
Moduleffizienz	145.64 lm/W
UGR Klasse	≤19
Abstrahlwinkel	35°
Versorgungsspannung	220 - 240 V / 50 - 60 Hz
Schutzklasse	I
Schutzart	IP20

## Abmessungen / Gewichte

Länge	226 mm
Breite	96 mm
Höhe	175 mm
Durchmesser Lichtkopf	96 mm
Nettogewicht	1.25 kg
Bruttogewicht	1.32 kg

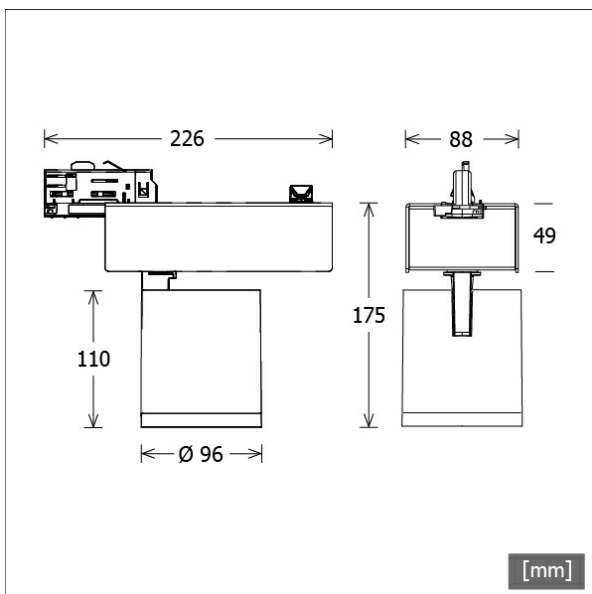

# SCOUT 202.940.35.2/DALI-ST

Scout Next (1xLED 21W 940/4000K 2430lm 35°)

C0/C180 cd / 1000 lm

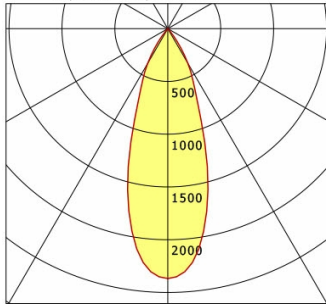

	C0	C90	C180	C270
0°	2368	2368	2368	2368
15°	1465	1465	1465	1465
30°	380	380	380	380
45°	11	11	11	11
60°	1	1	1	1
75°	0	0	0	0
90°	0	0	0	0

cd / 1000 lm

Offset [m] Cone width [m] Illuminance [lx]

Offset [m]	Cone width [m]	Illuminance [lx]
3.0	1.89	639.3
6.0	3.78	159.8
9.0	5.67	71.0
12.0	7.56	40.0
15.0	9.45	25.6

<b>η</b>	LED
Efficiency	116 lm/W
Direct/Indirect	↓ 100% / ↑ 0%
System Power	21 W
<b>UGR</b>	X=4H, Y=8H
Reflection factors	70/50/20
UGR C0/C180	17.3
UGR C90/C270	17.3
CIE Flux Codes	99 100 100 100 100
Ra/CRI	>90

LTS

## Zubehör



**ST-A 10/9000A-1-ST**  
Anbau-Stromschiene ONETrack Advance mit Datenbus  
(Länge: 1000 mm)



**ST-A 20/9000A-2-ST**  
Anbau-Stromschiene ONETrack Advance mit Datenbus  
(Länge: 2000 mm)



**ST-A 30/9000A-3-ST**  
Anbau-Stromschiene ONETrack Advance mit Datenbus  
(Länge: 3000 mm)



**ST-A 40/9000A-4-ST**  
Anbau-Stromschiene ONETrack Advance mit Datenbus  
(Länge: 4000 mm)



**ST-E 10/9000-1-R**  
Einbau-Stromschiene ONETrack mit Datenbus  
(Länge: 1000 mm)



**ST-E 20/9000-2-R**  
Einbau-Stromschiene ONETrack mit Datenbus  
(Länge: 2000 mm)



**ST-E 30/9000-3-R**  
Einbau-Stromschiene ONETrack mit Datenbus  
(Länge: 3000 mm)



**ST-E 40/9000-4-R**  
Einbau-Stromschiene ONETrack mit Datenbus  
(Länge: 4000 mm)



**ZBK 13**  
Blendklappe



**ZBW 87**  
Wabenraster