

LED recessed spot
 Artikel-Nr. 12292023

Licht.
 Für Generationen.

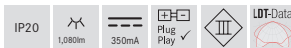
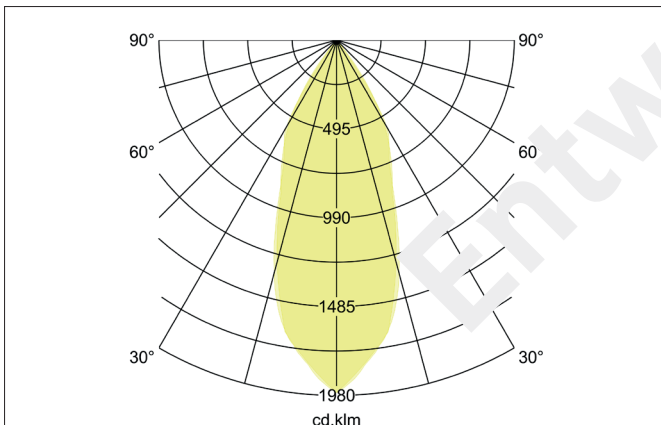
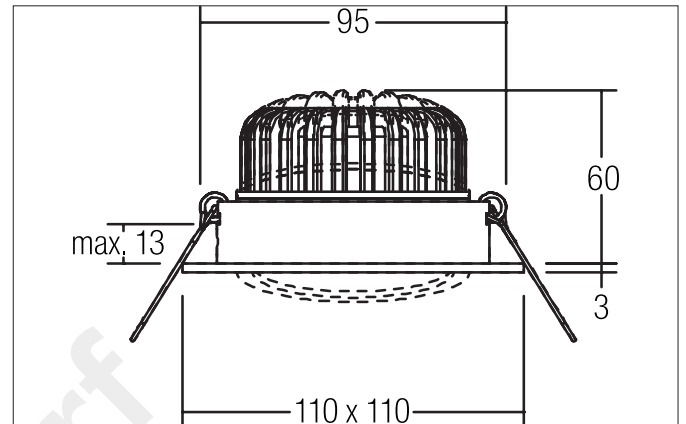

Tender

LED recessed spot, chrome, square. In a compact design, for installation in tool-less rapid assembly systems Lamp holder: Plug&Play, Mounting method: Recessed mounting, Place of installation: Ceiling-mounted, Material: Aluminium / Glass, Degree of protection: according to DIN EN 60529 IP20, Protection class: (EN 61140) III, Current: 350 mA, Power: 12W, Amount of light sources / fittings: 1.0 Qty, Luminous flux: 1.080lm, Colour temperature: 2.700 K, Light colour : White, Beam angle: 38°, Adjustability: Pivoted, With control gear: No, Control: Dimming depending on driver.

| Article data | |
|--------------------|-------------------|
| Artikel-Nr. | 12292023 |
| GTIN | 42500477 10431 |
| Kurzbeschreibung | LED recessed spot |
| Material | Aluminium / Glass |
| Colour | Chrome |
| Type of surface | Glossy |
| Shape | square |
| Built-in diameter | 95 mm |
| Installation depth | 60 mm |
| Length | 110 mm |
| Width | 110 mm |
| weight | 0.280 kg |

LED recessed spot
Artikel-Nr. 12292023Licht.
Für Generationen.









| Lighting technology | |
|---------------------|------------|
| Colour temperature | 2700 K |
| Light colour | White |
| Light output | Direct |
| Luminous flux | 1,080 lm |
| Colour rendering | CRI > 80 |
| Reflector | High-gloss |
| Beam angle | 38 ° |
| Light sharing | Symmetric |

| Operating technology of the luminaires | |
|--|---|
| System output | 12 W |
| Voltage type | DC |
| Current | 350 mA |
| Lamp | LED |
| Lamp holder | Plug&Play |
| Protection class | III |
| Degree of protection | IP20 |
| Converter - possible luminaire 1 pc. | 17613 17621 17622 17623 17624 17625 17626 17627 17628 17629 17630 17631 17632 17633 17634 17635 17636 17637 17638 17639 17640 17641 17642 17643 17657 17683 17648 17671 17672 |
| Control | Dimming depending on driver |
| Leuchtmittelwechsel möglich | ja |

| Mounting technology | |
|-----------------------|---|
| Mounting method | Recessed mounting |
| Place of installation | Ceiling-mounted |
| Adjustability | Tilted |
| Swivel angle | 15° |
| Further references | No cover with thermal insulation material |
| Material cover | Glass transparent |

| Packing data | |
|---------------------|---------|
| Gross weight | 0.33 kg |
| Length of packaging | 140 mm |
| Packaging width | 110 mm |
| Packaging height | 120 mm |

LED recessed spot
Artikel-Nr. 12292023Licht.
Für Generationen.

| Accessories | |
|---|--|
|  | <p>Artikel-Nr.: 17613000 Kurzbeschreibung: LED converter 350 mA, on/off Leistung: 1 - 15 W Abmessung: 115 mm x 34 mm x 19 mm</p> |
|  | <p>Artikel-Nr.: 17621020 Kurzbeschreibung: LED converter 350 mA, on/off Leistung: 1 - 21 W Abmessung: 128 mm x 50 mm x 13 mm</p> |
|  | <p>Artikel-Nr.: 17664020 Kurzbeschreibung: LED converter 350 mA, trailing-edge phase dimmable Leistung: 10,2 - 14 W Abmessung: 125 mm x 50 mm x 20 mm</p> |
|  | <p>Artikel-Nr.: 17643000 Kurzbeschreibung: LED converter 350 mA, trailing-edge phase dimmable Leistung: 8,0 - 18 W Abmessung: 110 mm x 52 mm x 22 mm</p> |
|  | <p>Artikel-Nr.: 17657000 Kurzbeschreibung: LED converter 350 mA, 1-10 V dimmable (analog) Leistung: 5,2 - 18 W Abmessung: 110,5 mm x 52 mm x 22 mm</p> |
|  | <p>Artikel-Nr.: 17683020 Kurzbeschreibung: LED converter 350 mA, DALI dimmable (digital) Leistung: 3,5 - 17 W Abmessung: 110,5 mm x 52 mm x 22 mm</p> |
|  | <p>Artikel-Nr.: 17648020 Kurzbeschreibung: LED converter 350 mA, trailing-edge phase dimmable Leistung: 0,7 - 17 W Abmessung: 166 mm x 46 mm x 34 mm</p> |
|  | <p>Artikel-Nr.: 17671020 Kurzbeschreibung: LED converter 350 mA, ZigBee dimmable Leistung: 3,5 - 18,5 W Abmessung: 146,5 mm x 44 mm x 30 mm</p> |
|  | <p>Artikel-Nr.: 17672020 Kurzbeschreibung: LED converter 350 mA, Casambi dimmable Leistung: 3,5 - 18 W Abmessung: 146,5 mm x 44 mm x 30 mm</p> |