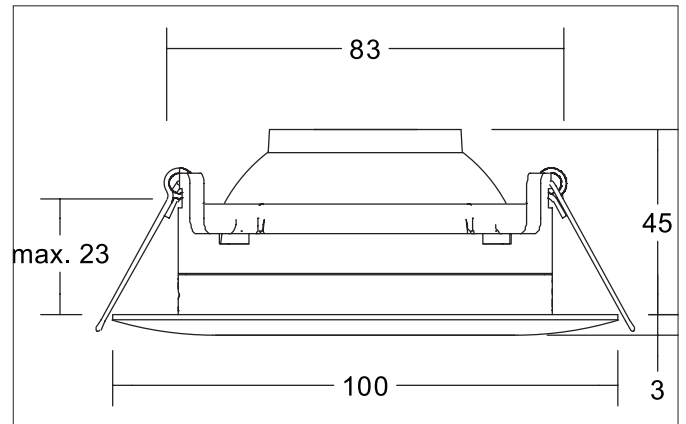

KYARY LED recessed spot

Article no. 12430173

Light.
For Generations.**Tender**

LED recessed spot, Round. Toolless ceiling installation by installation springs. Ceiling cut-out \varnothing 83 mm, Installation depth 45 mm, Outer diameter 100 mm, Weight 0,242 kg, Reflector silver with rotationssymmetrical, deep, wide distributed light intensity. optimal light distribution due to a plastic, transparent cover. Luminous flux 630 lm, Power 1 x 5 W, Light colour warm white, Correlated color temprature (CCT) 3.000 K, Colour rendering index CRI > 80, Housing material: Aluminium / PMMA, Colour: White structure, Permissible ambient temperature (ta): -20 °C - +25 °C, Protection class (EN 61140): III, Degree of protection (DIN EN 60529): IP20, .For connection to an external driver, which is not included in the scope of delivery of the luminaire. Depending on driver dimmable.

Product Benefits

- Recessed spotlight in round design made of solid aluminum.
- Ceiling cutout 83 mm, outer diameter 100 mm, Installation depth 45 mm, luminous flux 620 lm, IP20.
- 360° rotatable.
- Pivoted.
- Dimmable when using a suitable converter.

KYARY LED recessed spot

Article no. 12430173

Light.
For Generations.

Article data	
Article no.	12430173
GTIN	4251433981435
Series name	KYARY
Short description	LED recessed spot
Material	Aluminium / PMMA
Colour	White
Type of surface	Structure
Shape	Round
Outer diameter	100 mm
Built-in diameter	83 mm
Installation depth	45 mm
Hight	3 mm
Weight	0.242 kg

Lighting technology	
Colour temperature	3.000 K
Light colour	White
Light output	Direct
Luminous flux	630 lm
System efficiency	126 lm/W
Colour rendering	CRI > 80
Reflector	High-gloss
Reflektorfarbe	silver
Beam angle	60°
Light sharing	Symmetric

Operating technology of the luminaire	
Voltage type	DC
Current	350 mA
Lamp	LED
Protection class	III
Degree of protection	IP20
Dimmable	Depending on type of control gear
Control	Depending on driver
Bulb change possible	The light source of this luminaire may only be replaced by the manufacturer or a service technician commissioned by him or a similarly qualified person.

Mounting technology	
Mounting method	Recessed mounting
Place of installation	Ceiling-mounted
Adjustability	Rotable and pivoted
Swivel angle	30°
Rotation angle	360°
Max. ceiling thickness	23 mm
Further references	No cover with thermal insulation material
Material cover	Plastic, transparent

Packing data	
Gross weight	0.36 kg
Length of packaging	115 mm
Packaging width	110 mm
Packaging hight	70 mm
Disposal at end of life	This product must not be disposed of with household waste. You are obliged, to dispose of such electrical waste separately. By disposing of electrical waste and other old or defective electronics separately, you support recycling or other forms of re-use. In that way you help to take care and to avoid that harmful substances get into the environment.

KYARY LED recessed spot
Article no. 12430173

Light.
For Generations.

Accessories