

1 2 3 4 5 6

A

B

C

D

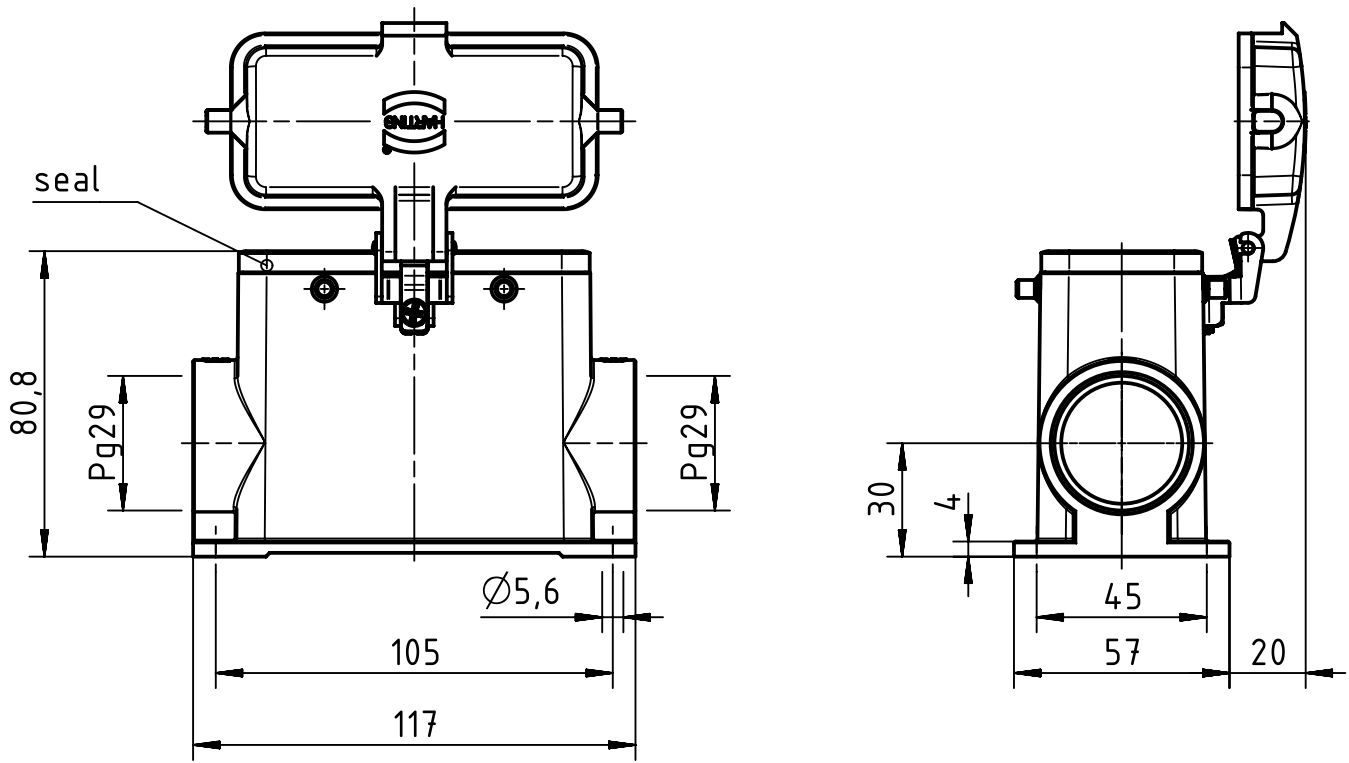
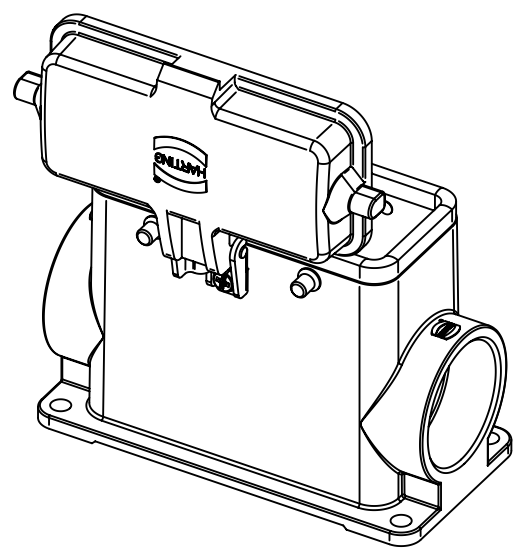

	All Dimensions in mm Original Size DIN A4		Scale 1:2	Free size tol.		Ref.
						Sub.
	All rights reserved		Created by FINKEV	Inspected by BERGHORN	Standardisation SCHMIDTM	Date 2016-06-01
	Department EL PD - DE					State Final Release
HARTING Electric GmbH & Co. KG D-32339 Espelkamp			Title Han 16B-asg2-K-29			Doc-Key / ECM-Nr. 100209876/UGD/004/A 500000104878
			Type TB	Number 09 30 016 0261		Rev. A Page 1/1