

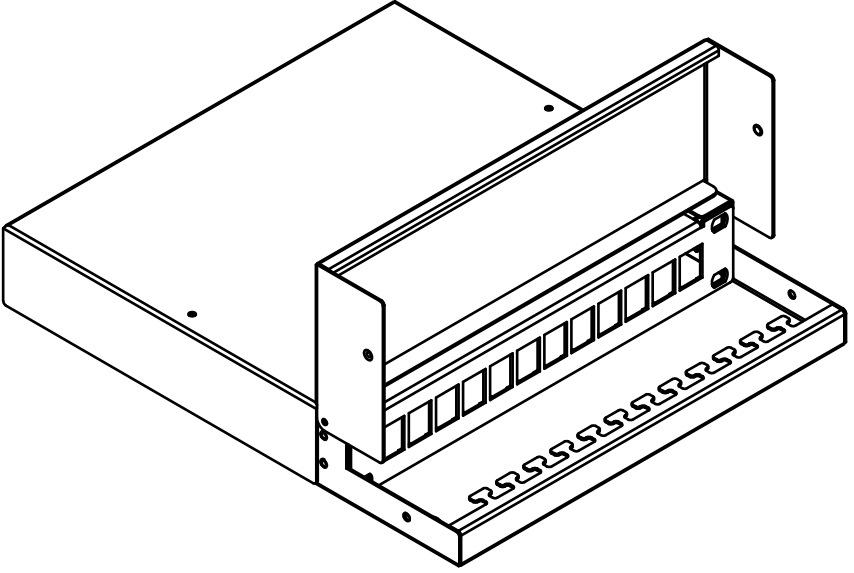

Alle Rechte vorbehalten / all rights reserved. ZVK GmbH, D-94244 Teisnach, Technologiecampus 2, Germany. Phone: +49 9923 804379-0, Fax: +49 9923 804379-50, www.zvk-gmbh.de, alle Angaben ohne Gewähr.

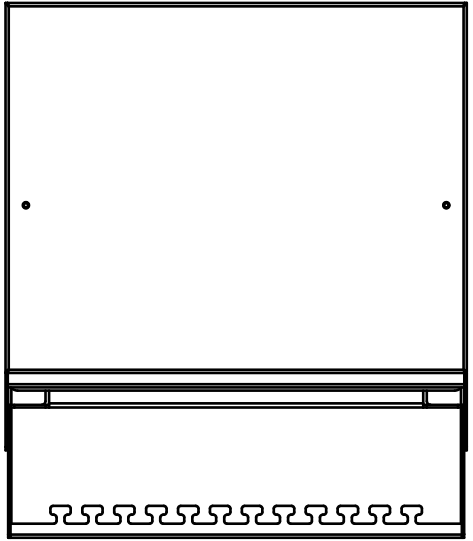
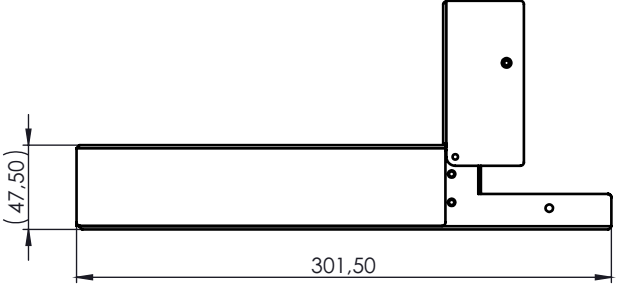
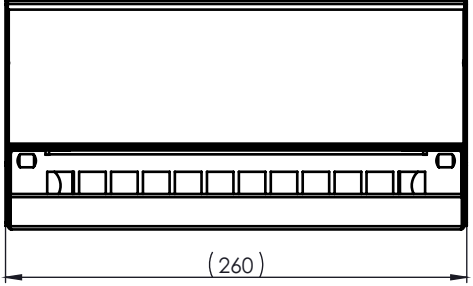

Stahlblech verzinkt, pulverbeschichtet

	gez. / drawn	01.03.2015	Kandler	 <b>EasyLan<sup>®</sup></b> ...for a better connectivity
	gepr. / appr.			
Titel / titel: Consolidation Point 10" 1HE für 12 Keystone Module				Maße / Dimensions: mm
Artikelnummer / article number: ZN-BL151025_A				Original: DIN A4
Änd./ rev. Index	Neuerstellung	01.03.15	Kandler	Blatt / sheet 1 von / of 2

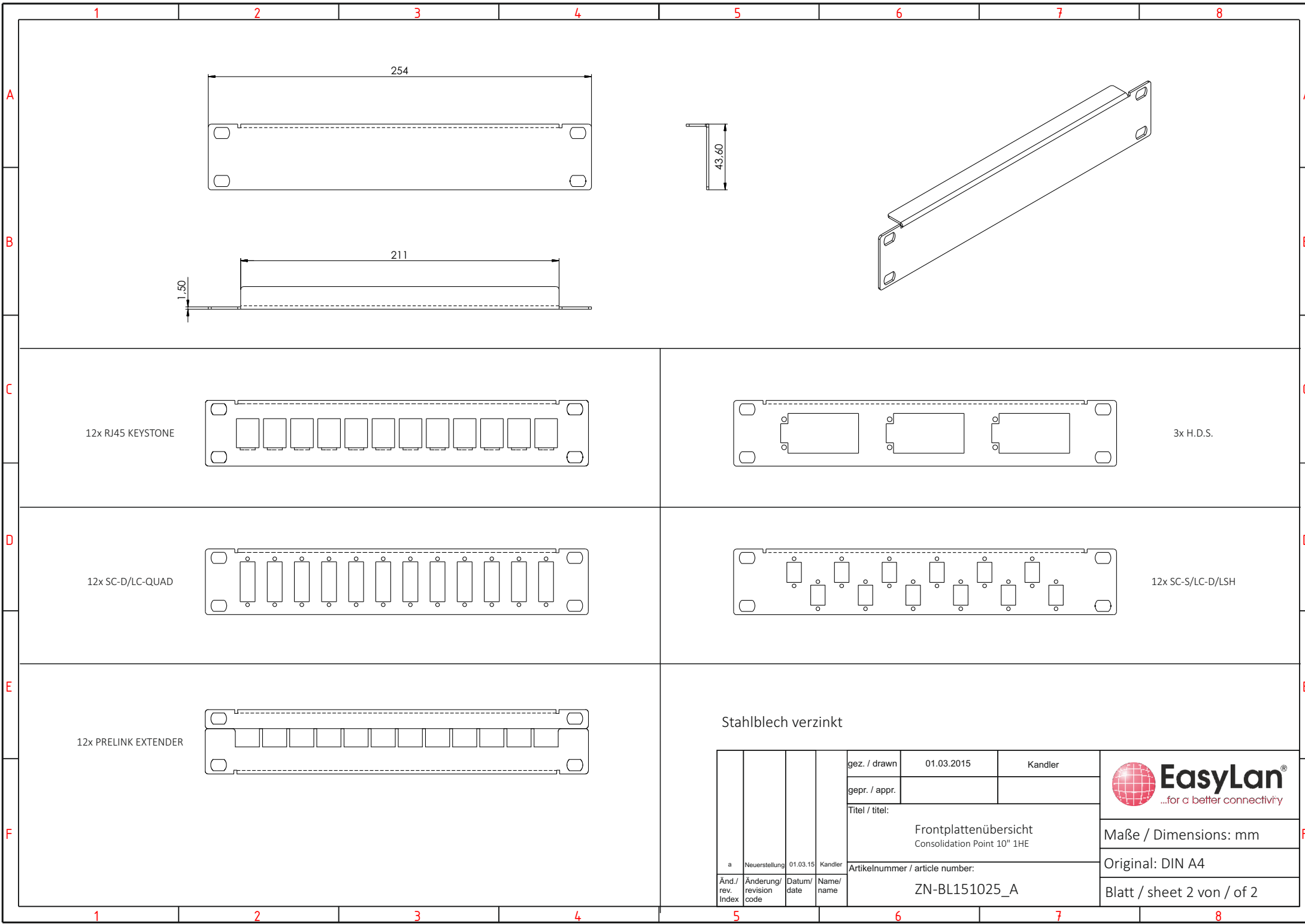

12x RJ45 KEYSTONE

3x H.D.S.

12x SC-D/LC-QUAD

12x SC-S/LC-D/LSH

12x PRELINK EXTENDER

Stahlblech verzinkt

a	Neuerstellung	01.03.15	Kandler	gez. / drawn	01.03.2015	Kandler
	Änd./rev. Index	Änderung/revision code	Datum/date	Name/name	gepr. / appr.	
Titel / titel:				Frontplattenübersicht Consolidation Point 10" 1HE		
Artikelnummer / article number:				ZN-BL151025_A		
				 <b>EasyLan</b> ...for a better connectivity		
				Maße / Dimensions: mm		
				Original: DIN A4		
				Blatt / sheet 2 von / of 2		