

1:5

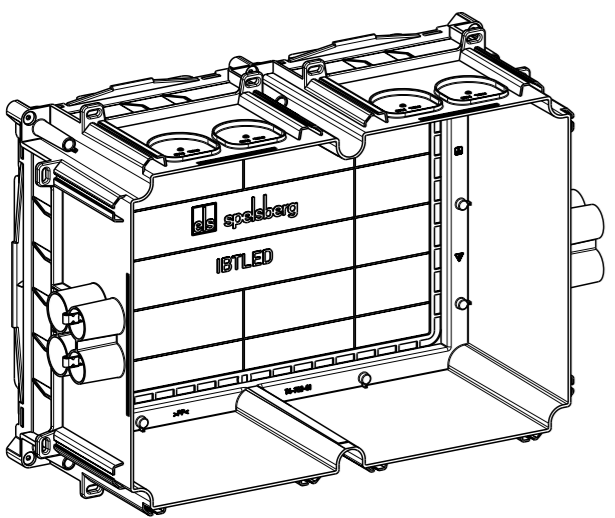
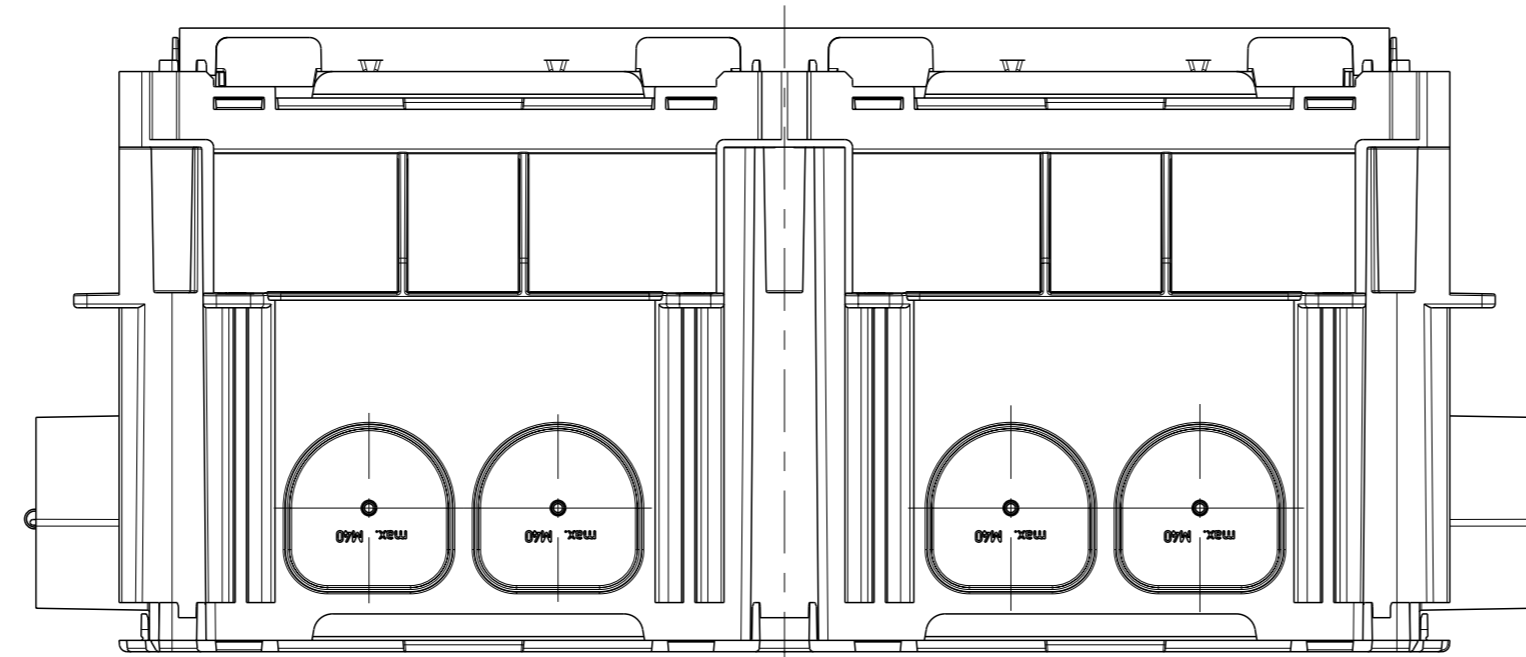
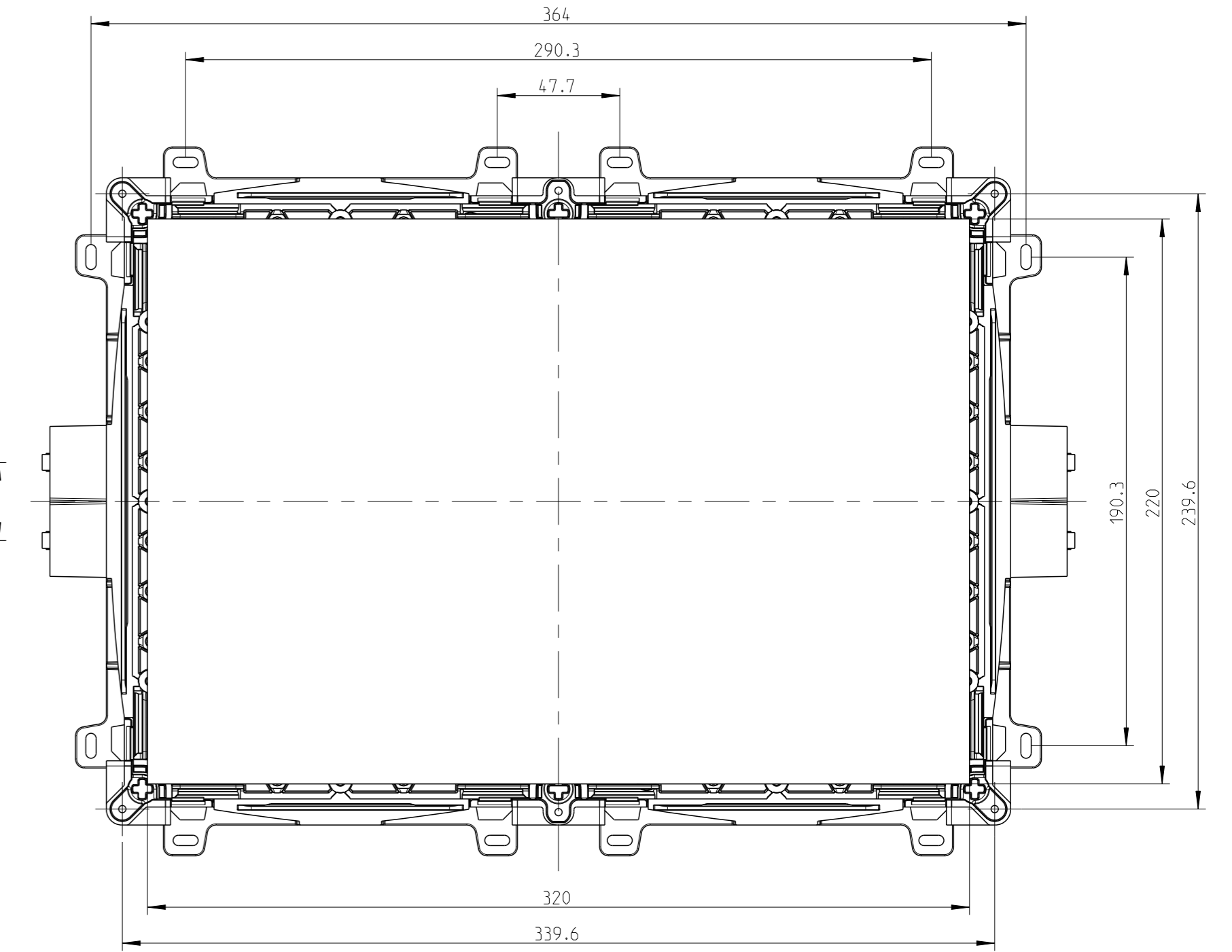
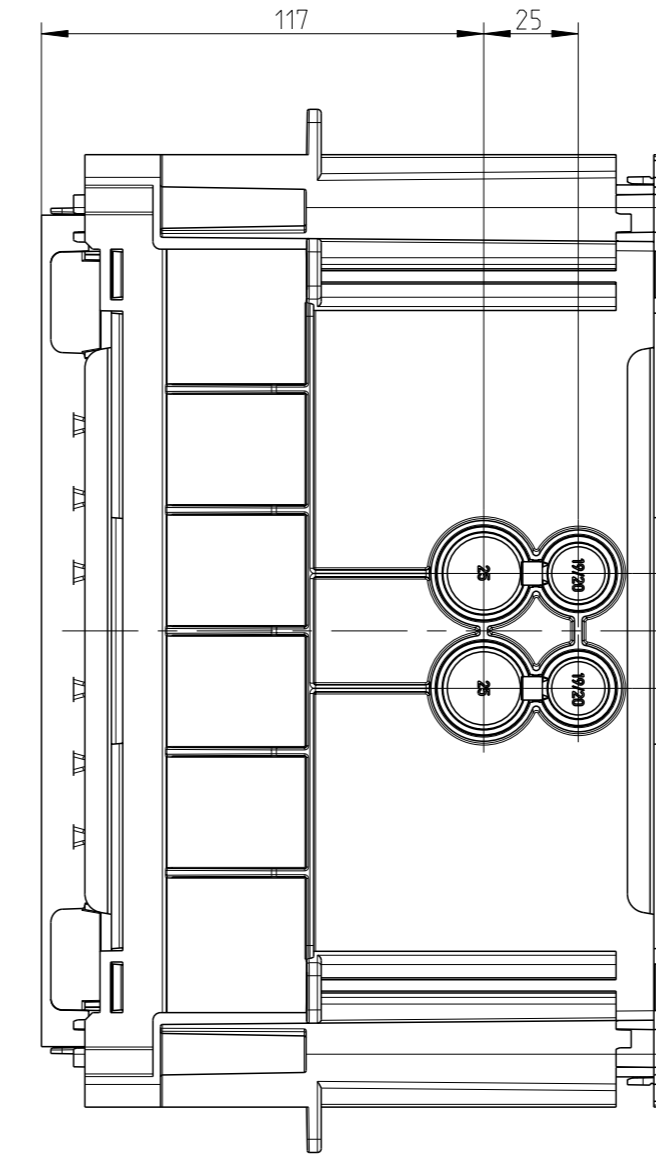
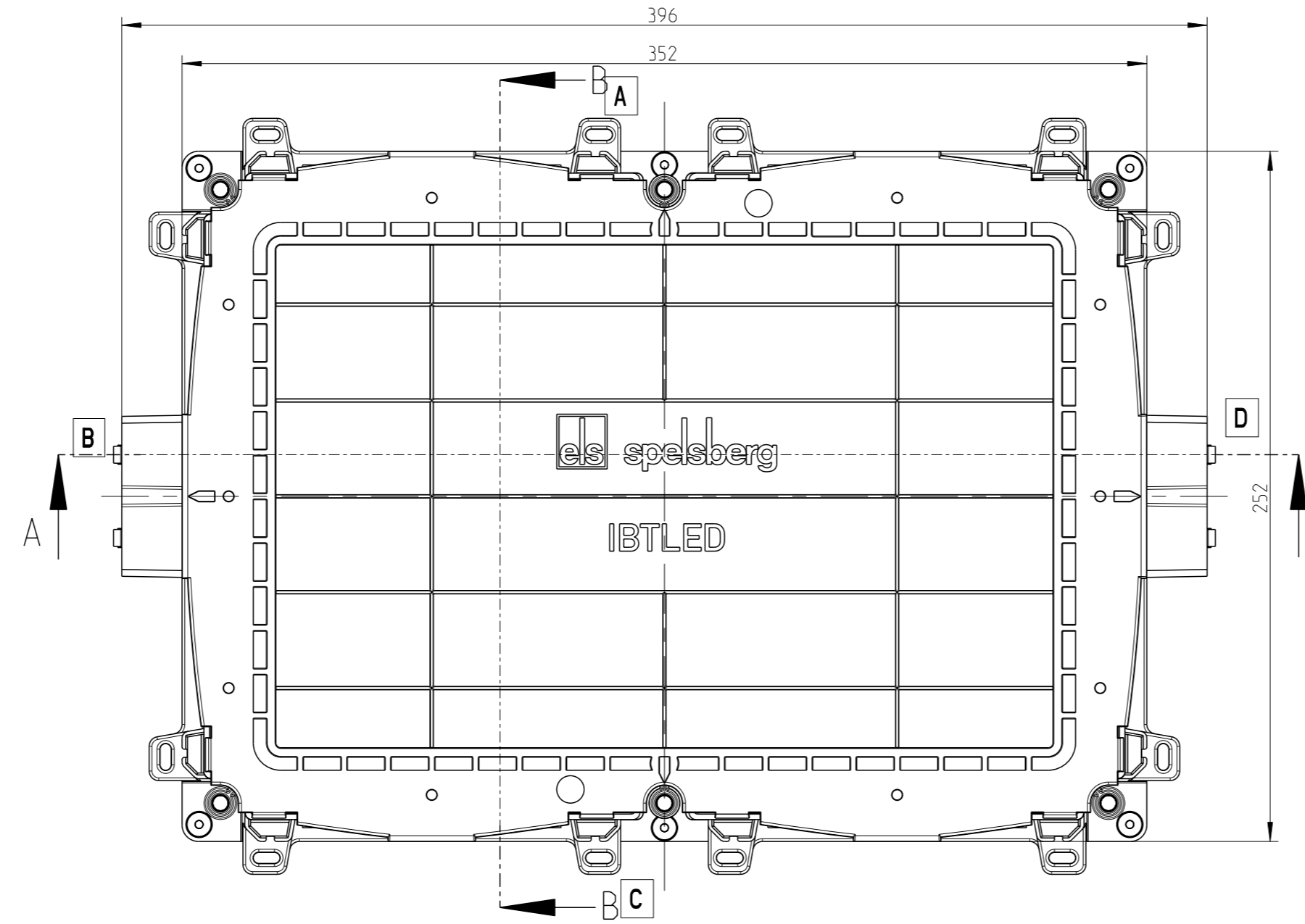
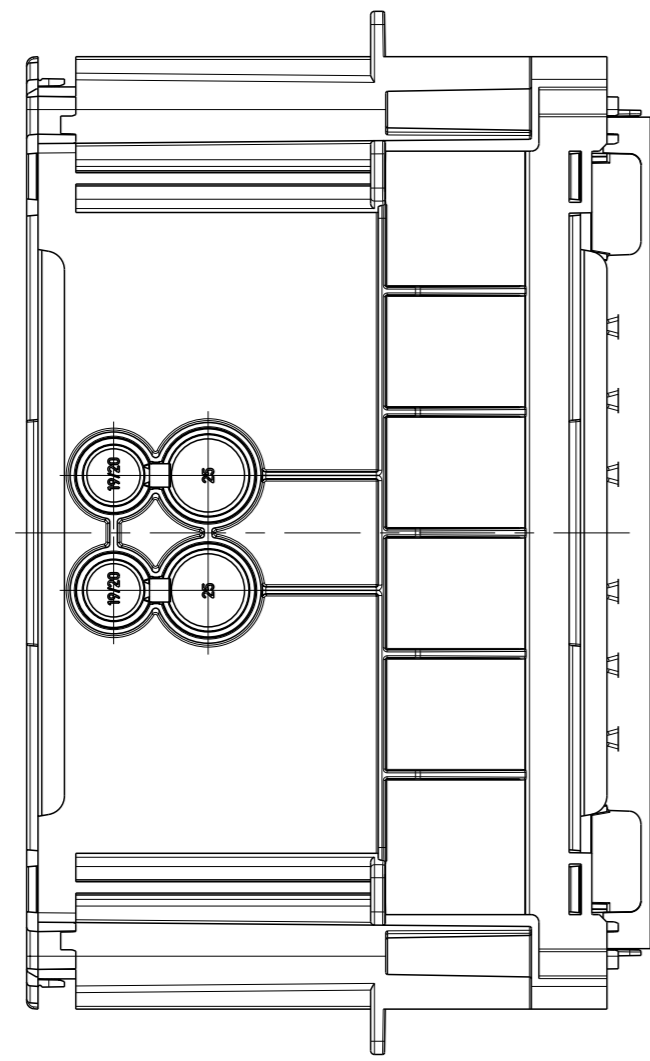
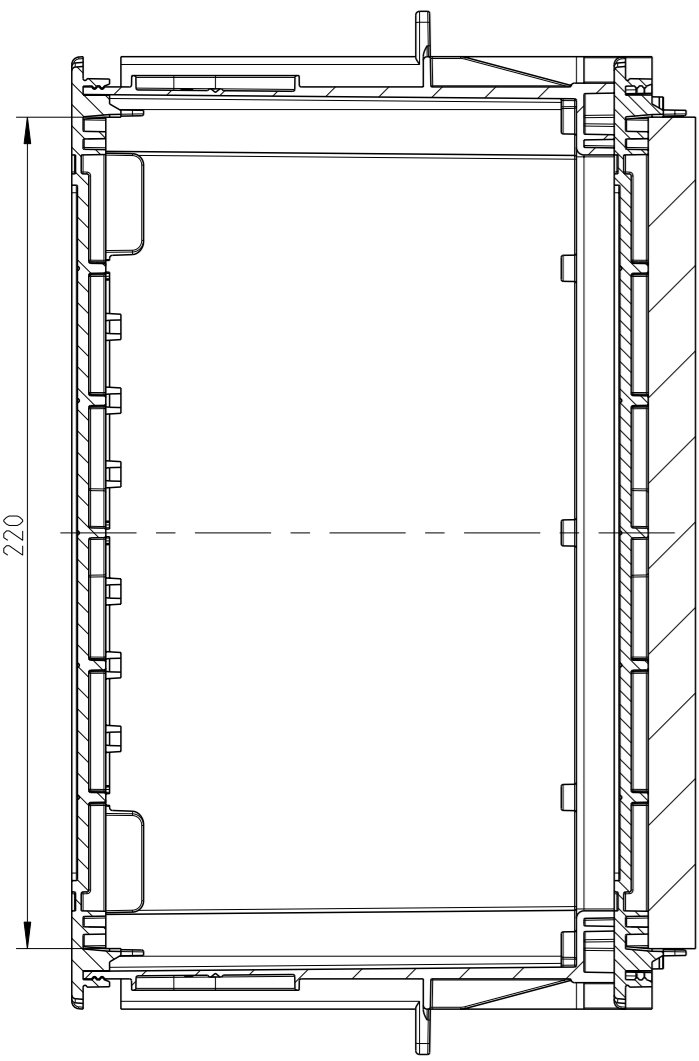
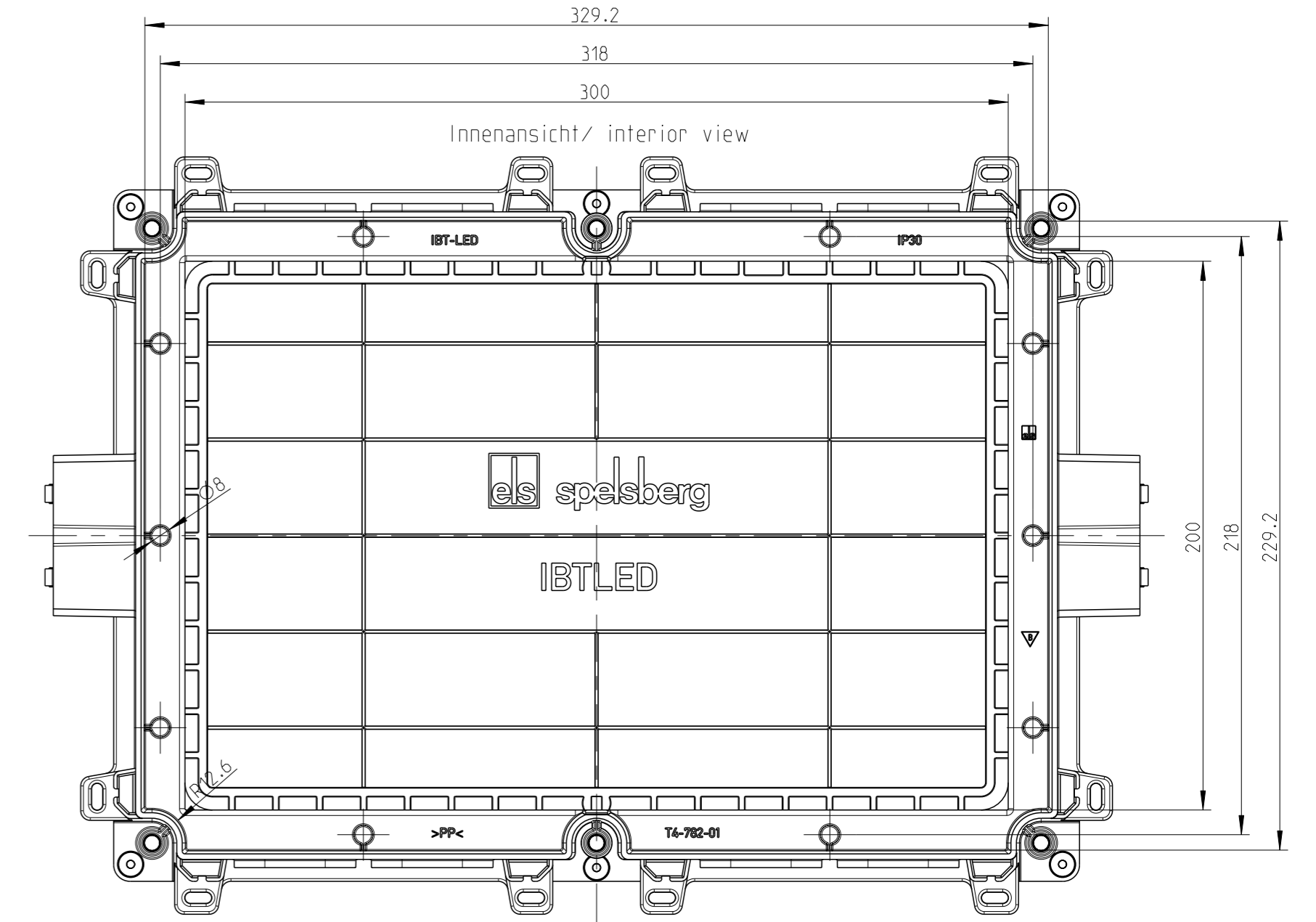
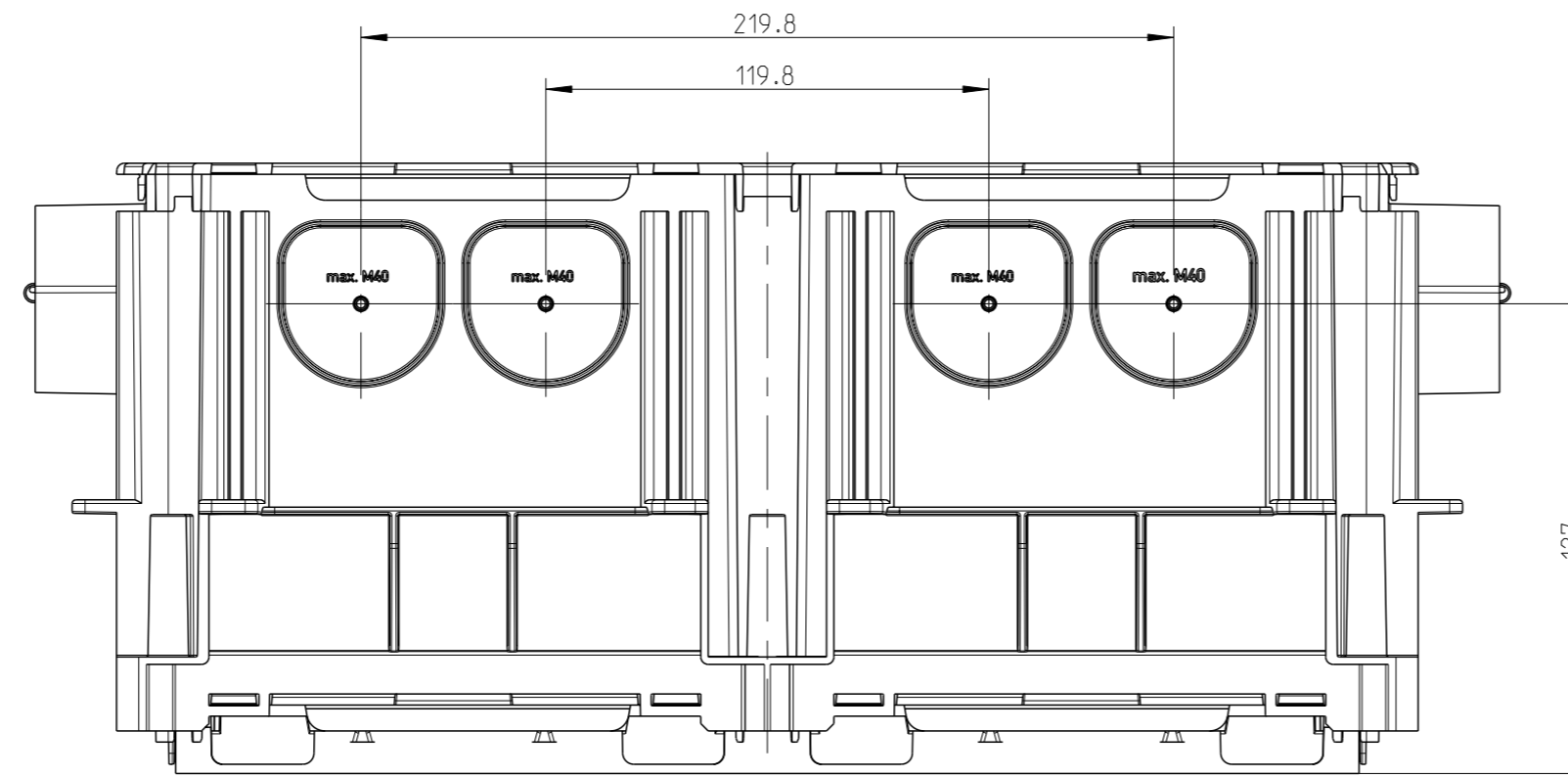
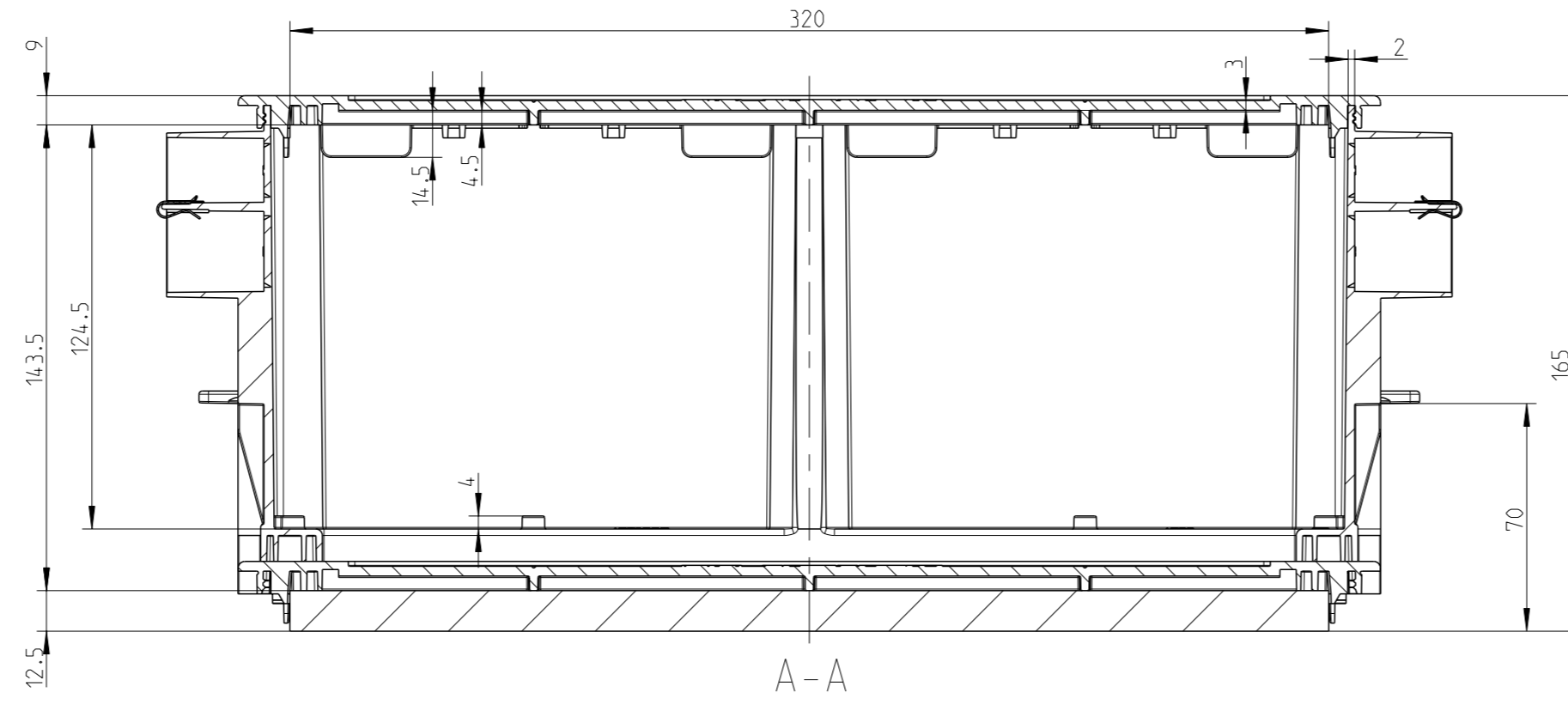

1:5

Fehlende Maße können dem DXF entnommen werden  
missing dimensions are provided in the DXF