

1:5

1:5

Innenansicht / interior view

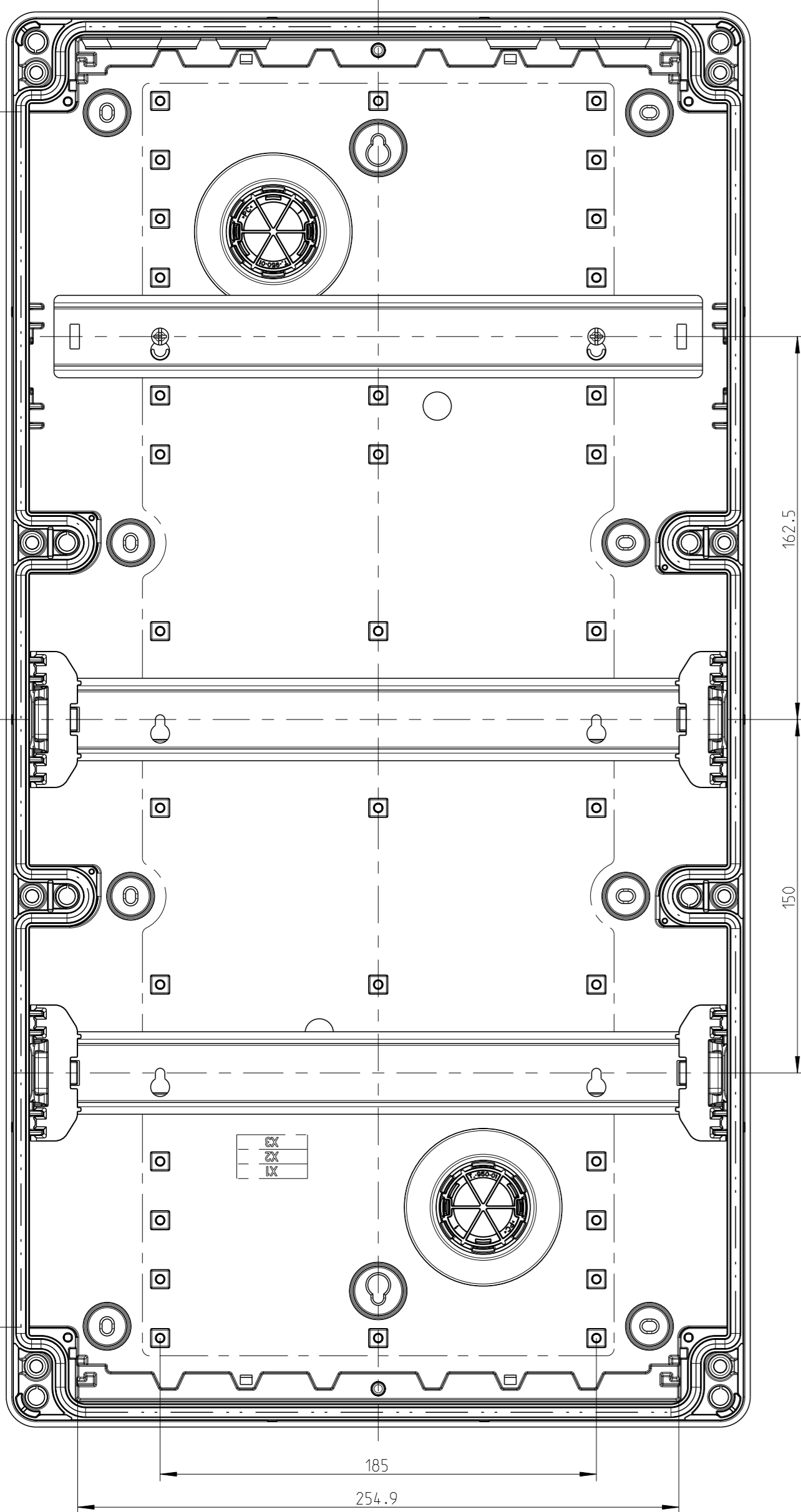

515.7

162.5

600.5

150

185

254.9

B-B

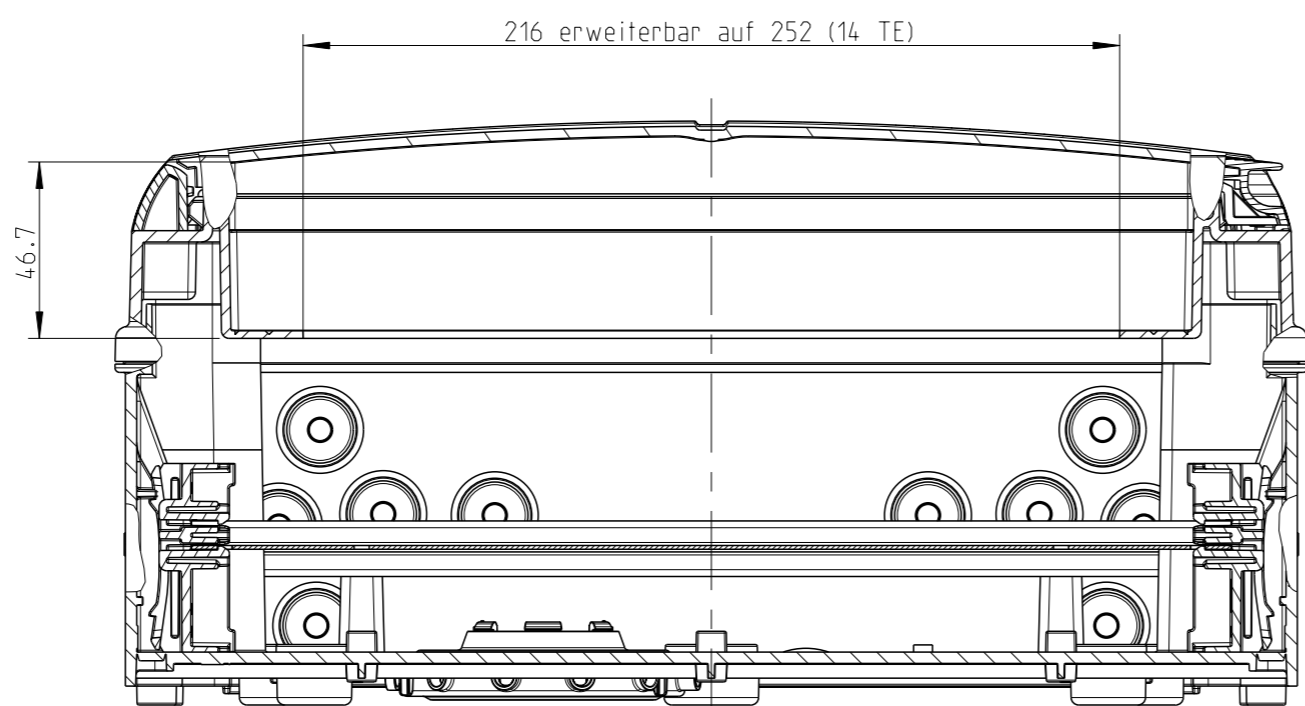

216 erweiterbar auf 252 (14 TE)

46.7

315.5

A

A

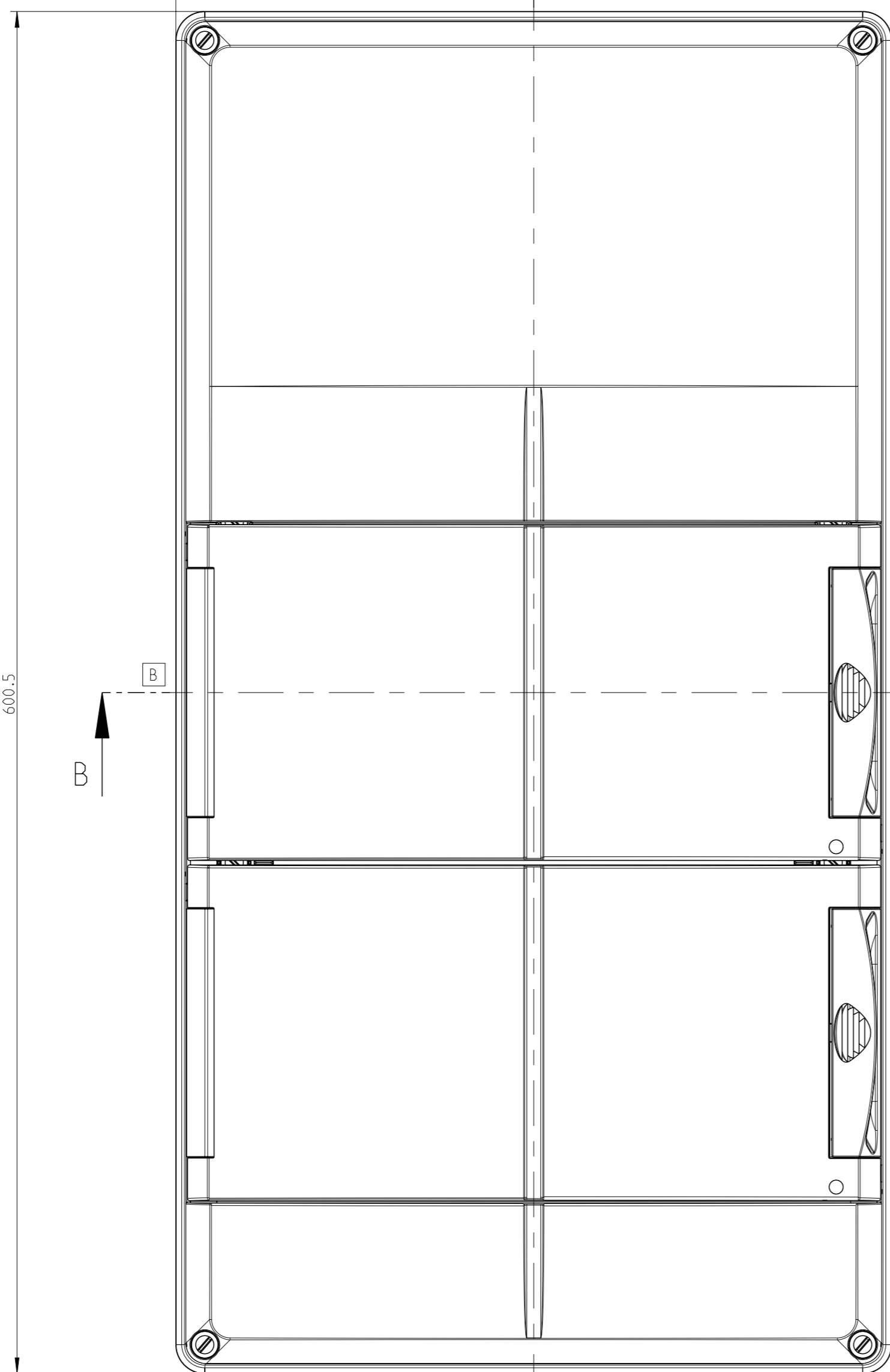

B

B

A

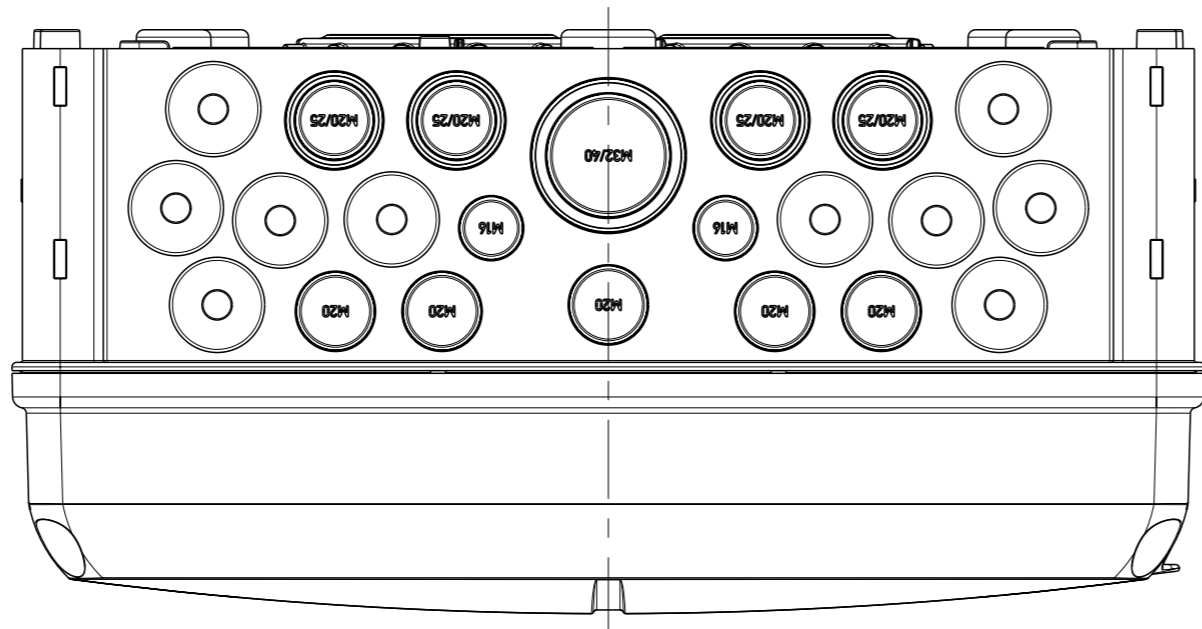

A-A

7.10

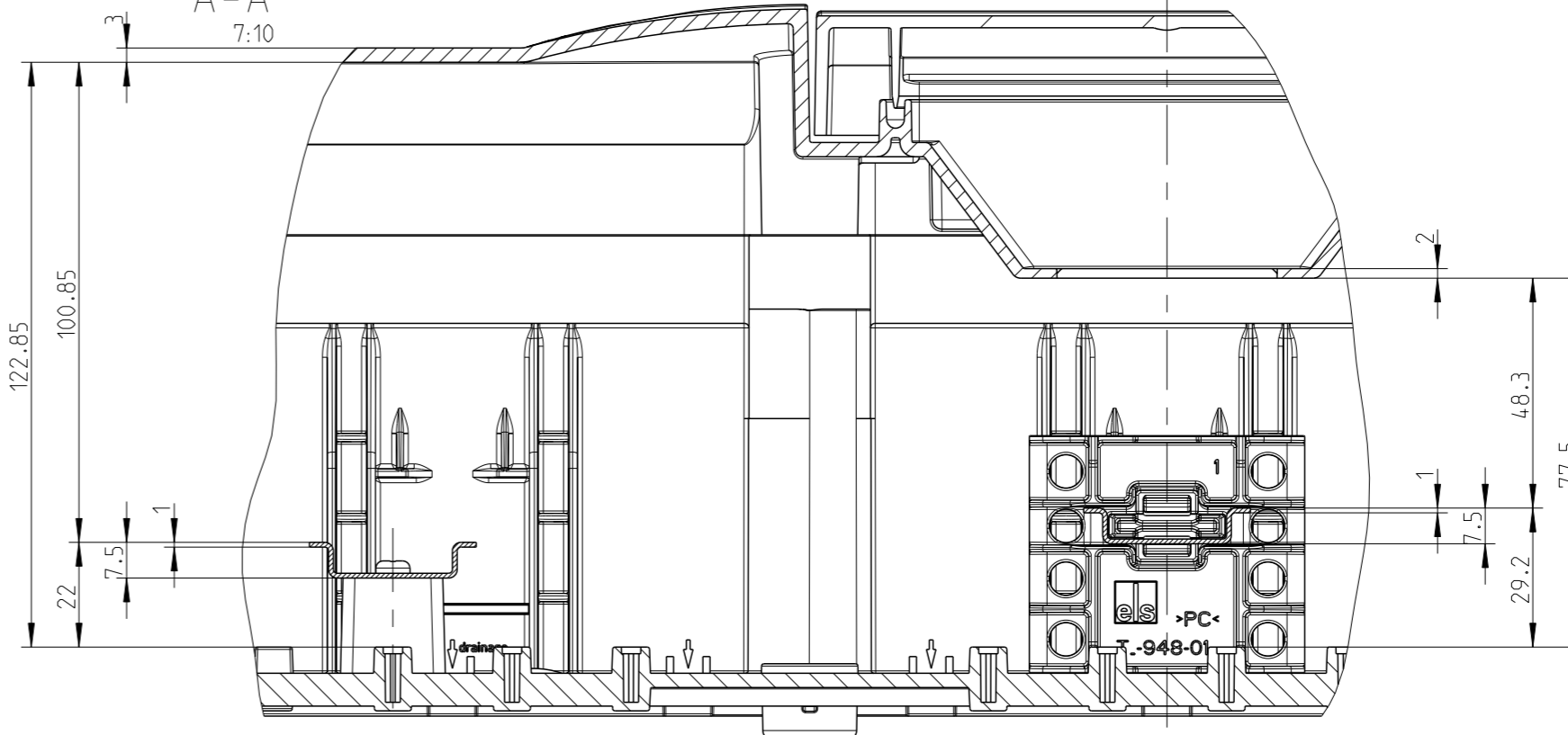

122.85

100.85

22

7.5

1

1

1

1

1

1

1

1

1

1

1

1

1

1

1

1

1

1

1

1

1

1

1

1

1

1

1

1

1

1

1

1

1

1

1

1

1

1

1

1

1

1

1

1

1

1

1

1

1

1

1

1

1

1

1

1

1

1

1

1

1

1

1

1

1

1

1

1

1

1

1

1

1

1

1

1

1

1

1

1

A-A

19.5

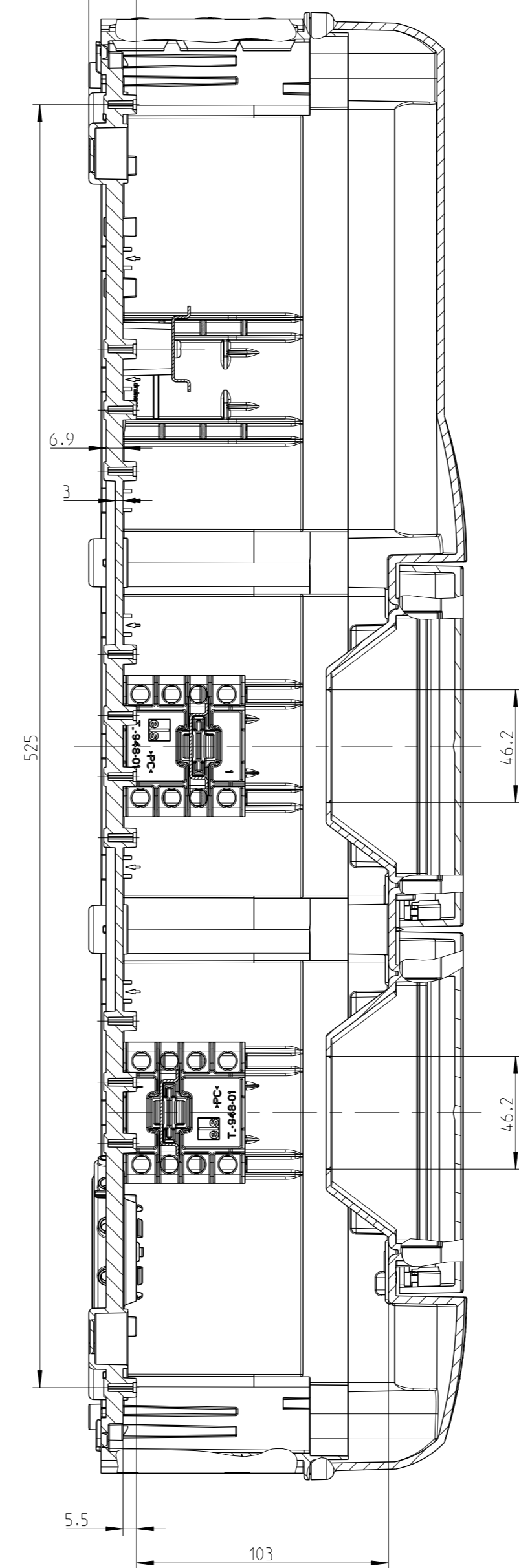

5.25

5.5

103

46.7

46.7

145.35

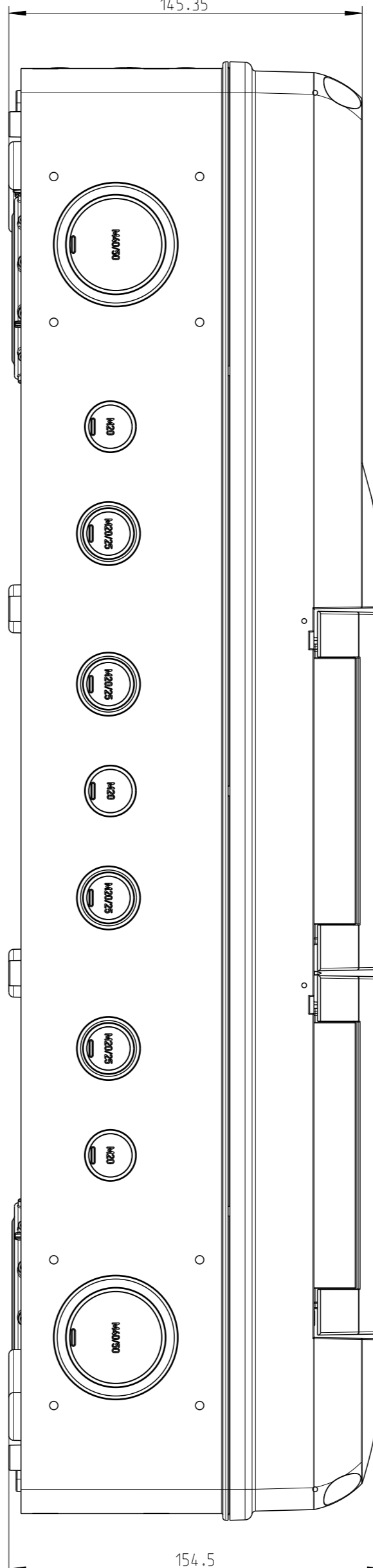

154.5

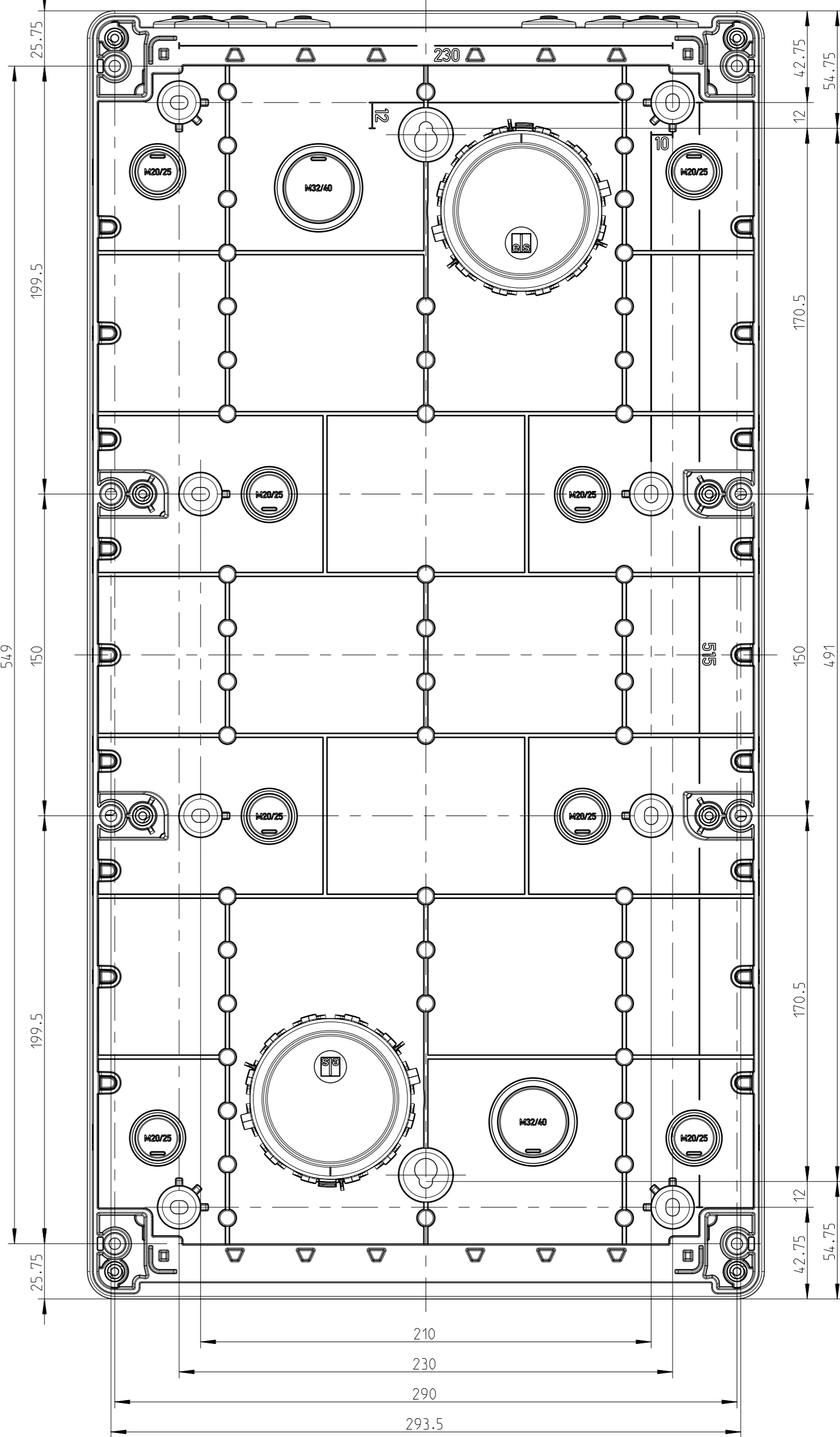

25.75

199.5

54.9

150

199.5

230

170.5

12

54.75

150

491

170.5

12

42.75

54.75

199.5

210

230

290

293.5

170.5

12

42.75

54.75

Fehlende Maße können dem DXF entnommen werden

missing dimensions are provided in the DXF