

BOTTOM VIEW

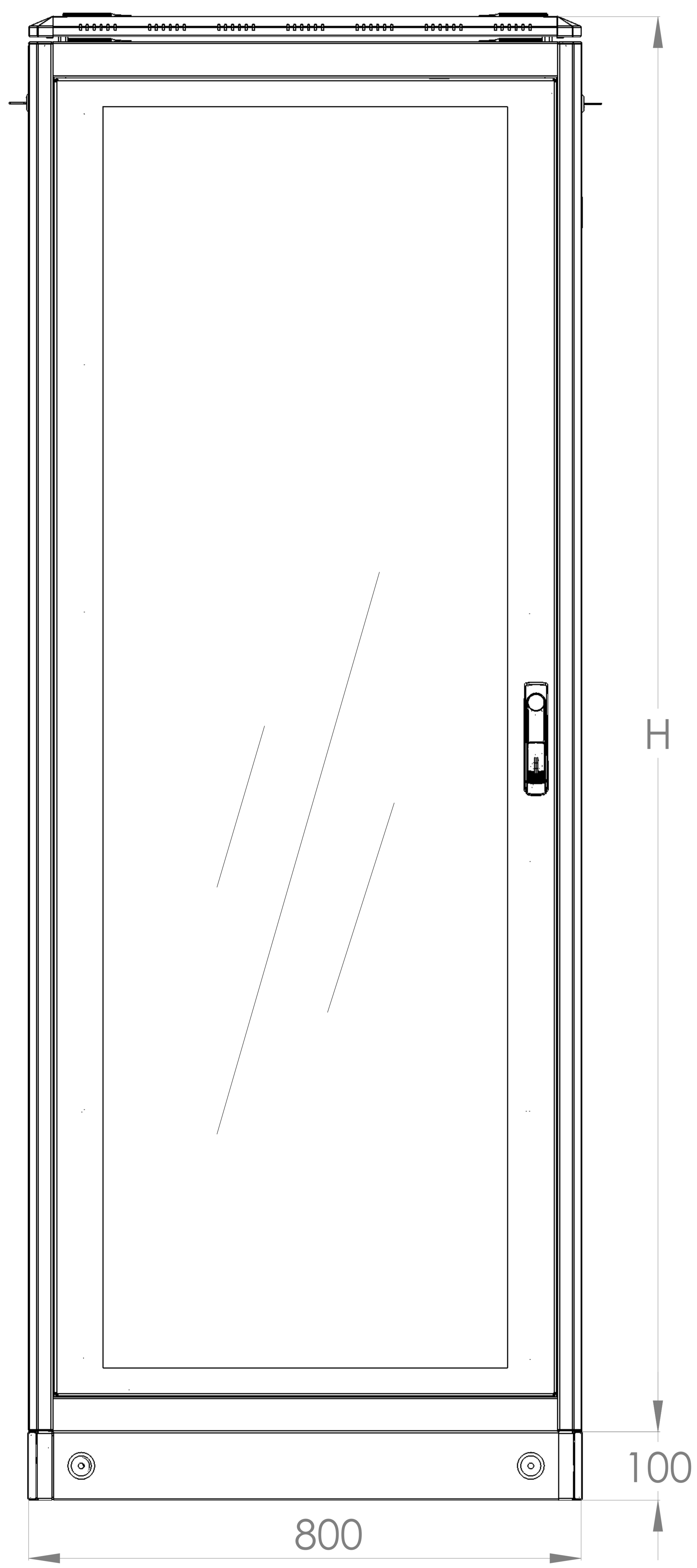

FRONT VIEW

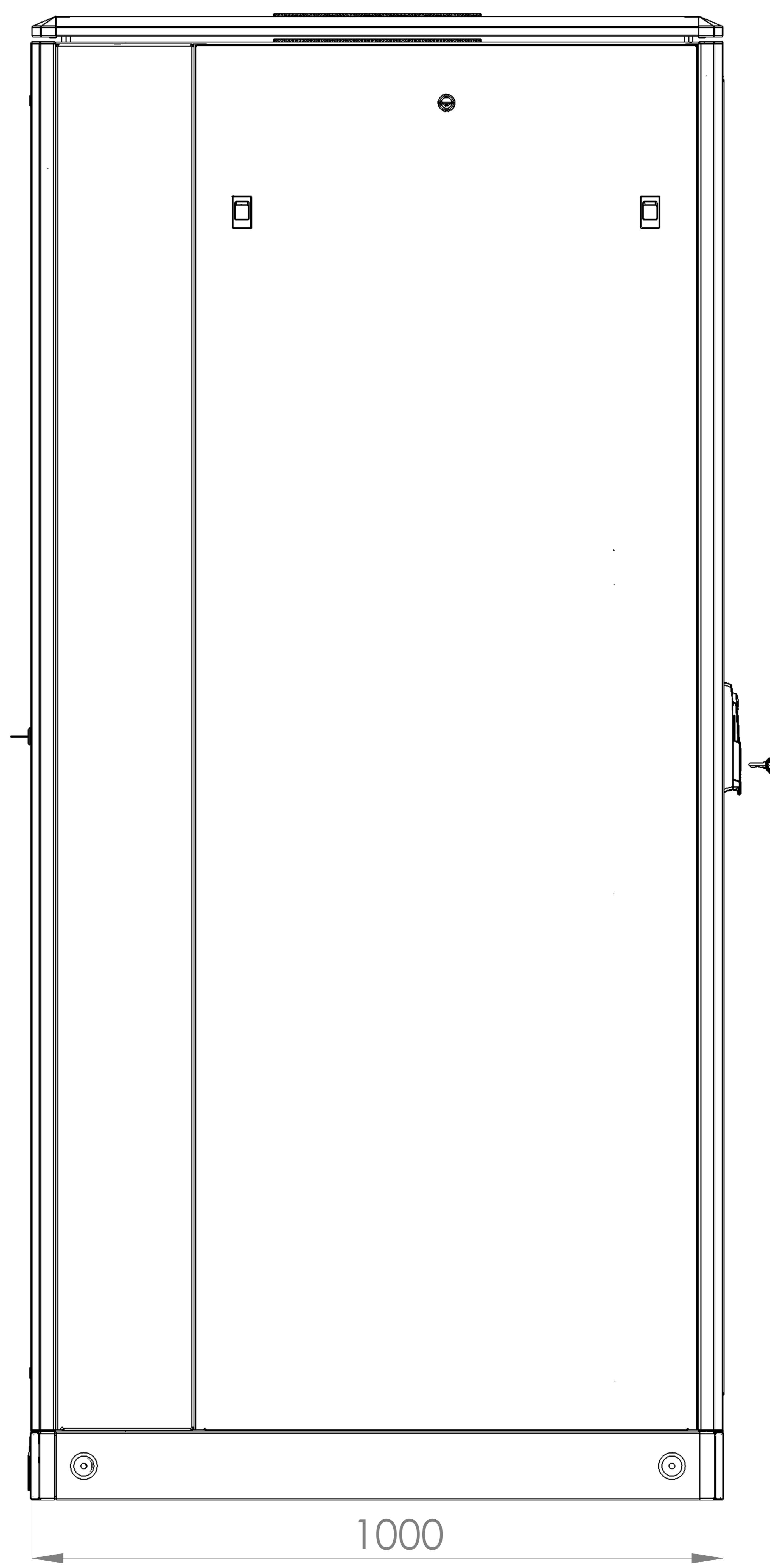

TOP VIEW

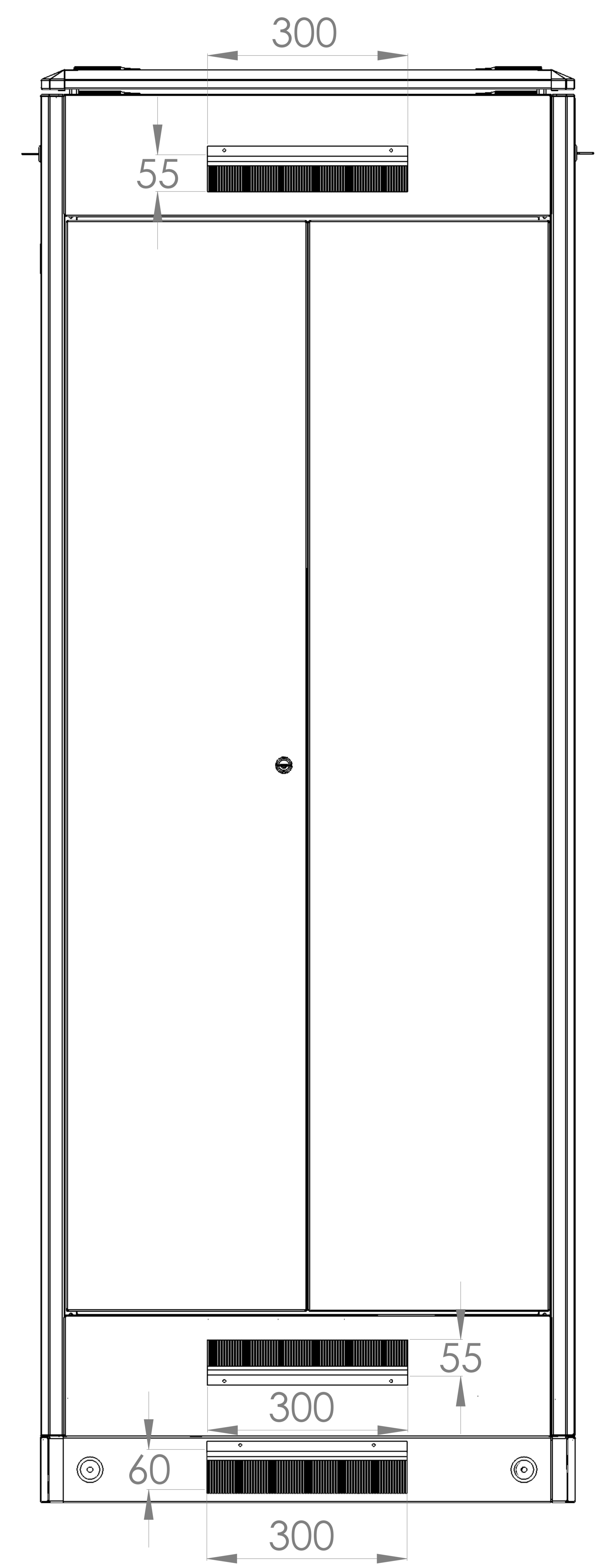

REAR VIEW

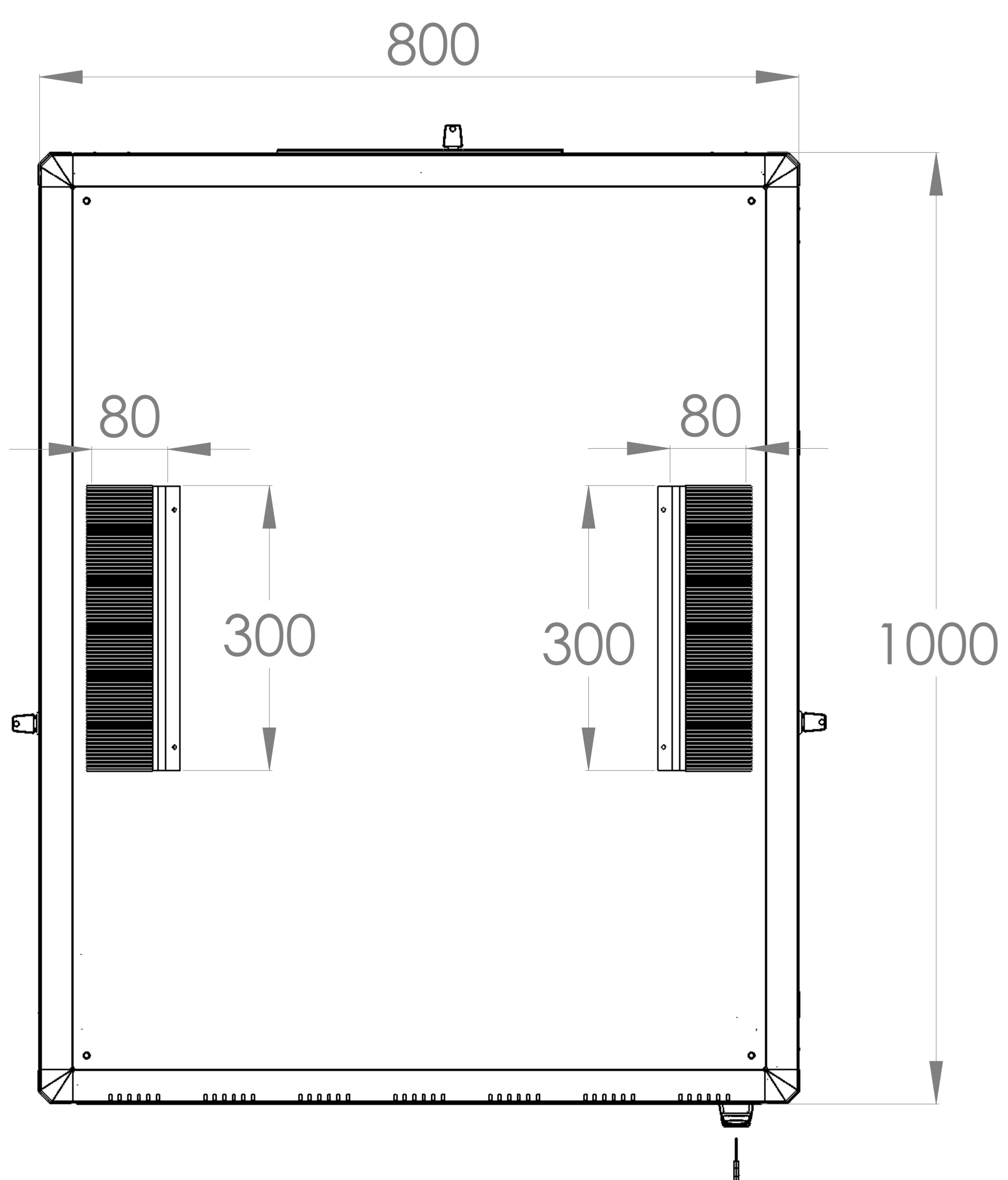

TOP VIEW

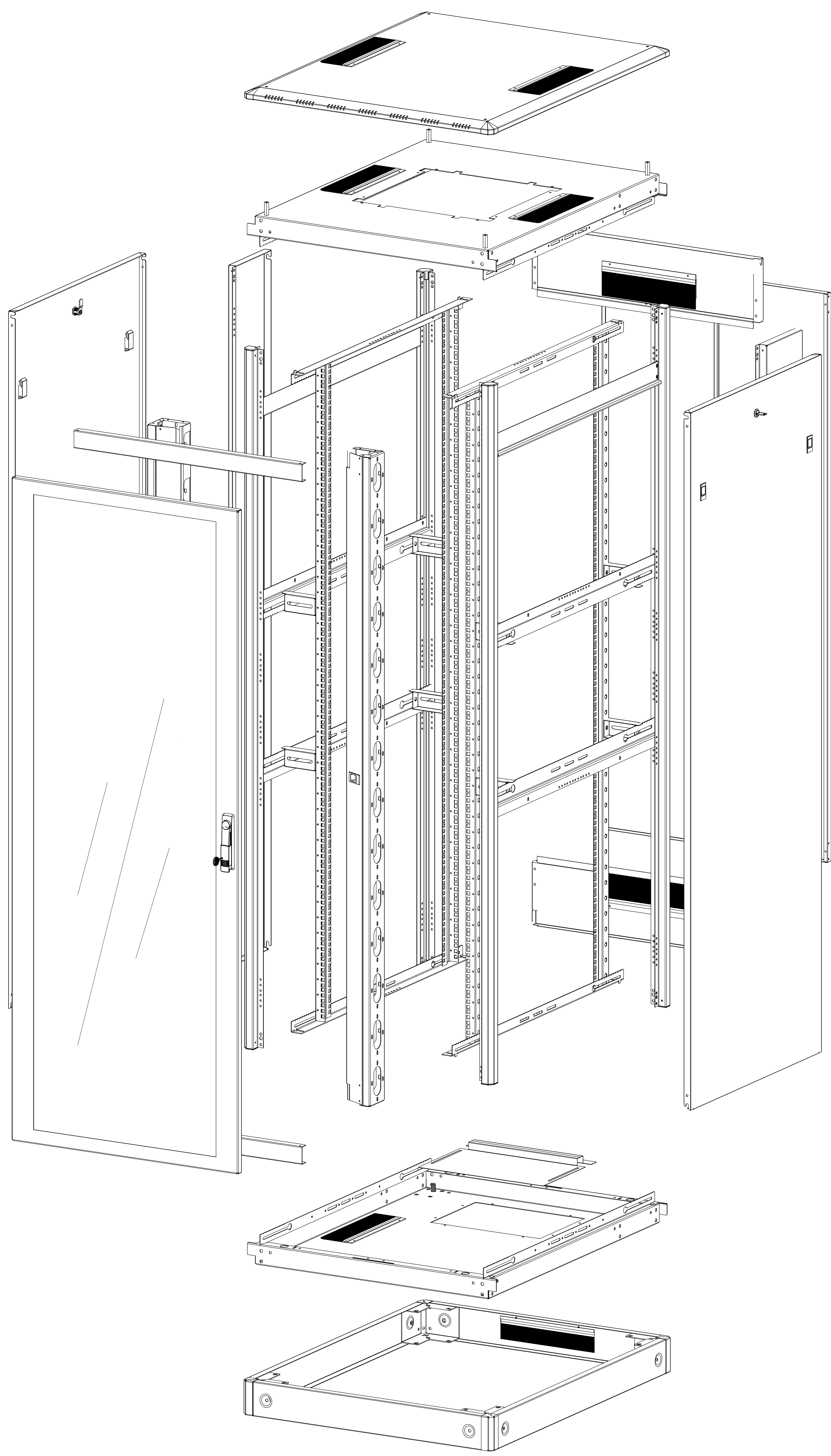

EXPLODED VIEW

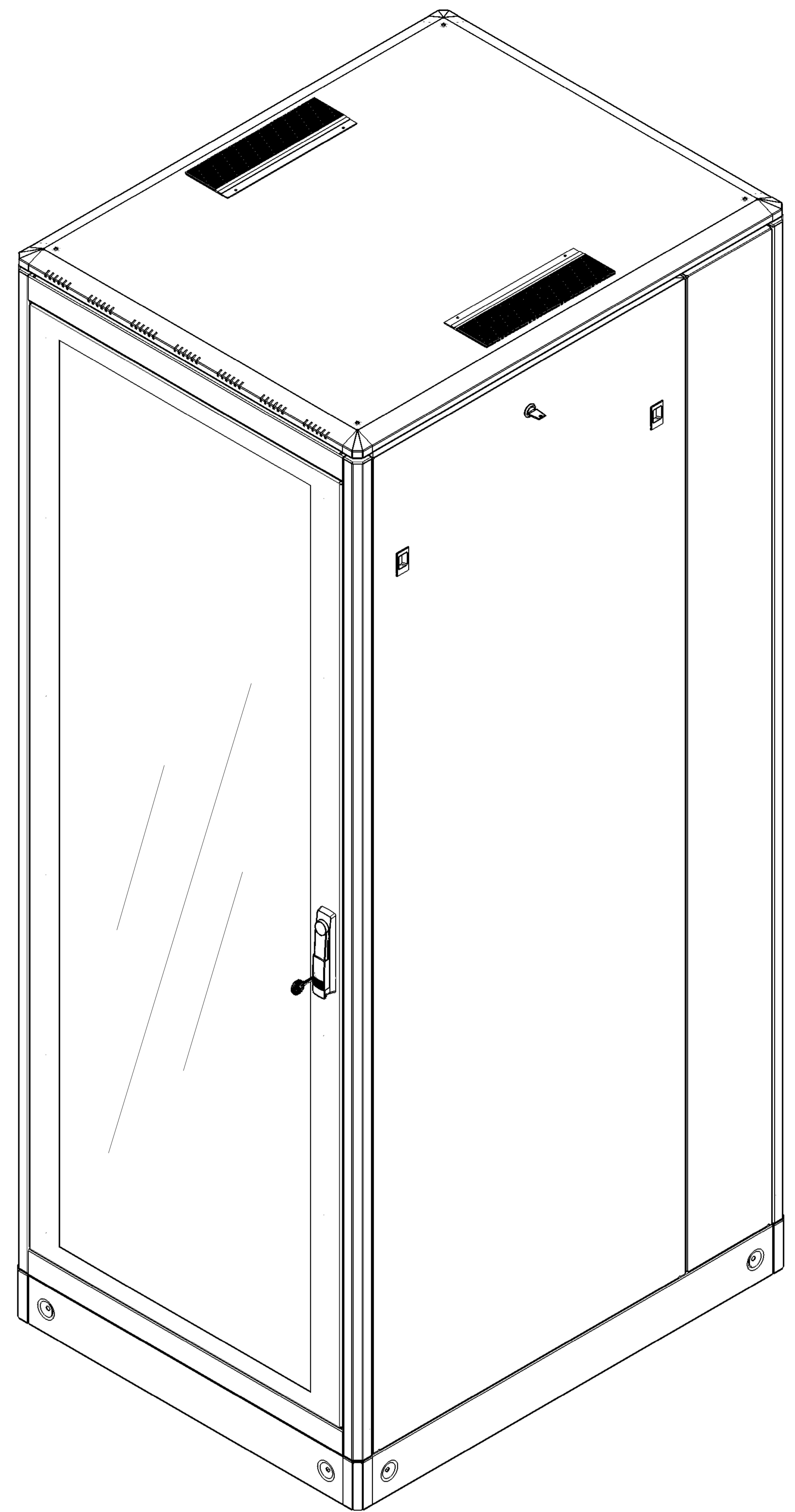

ISOMETRIC VIEW

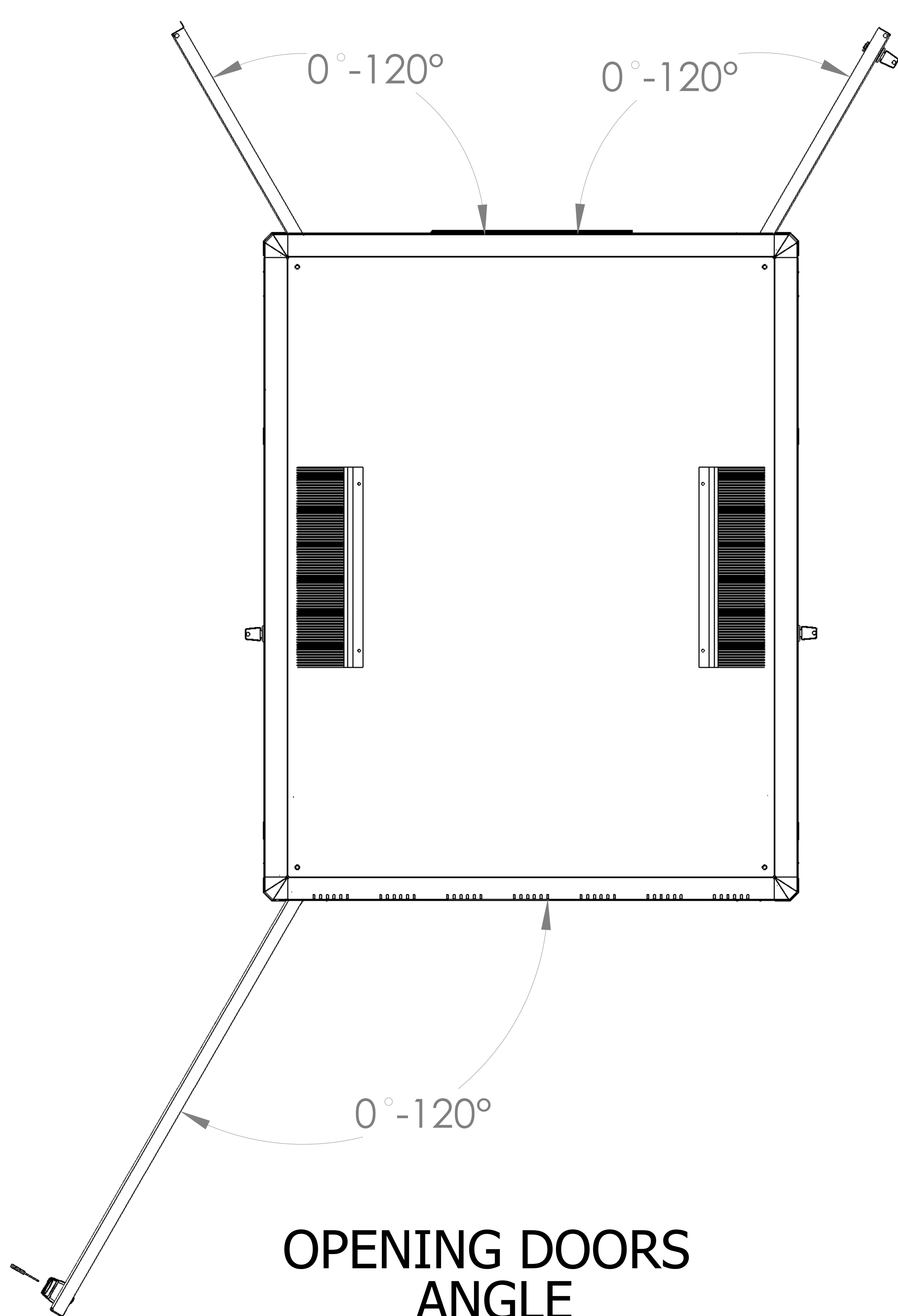

OPENING DOORS
ANGLE

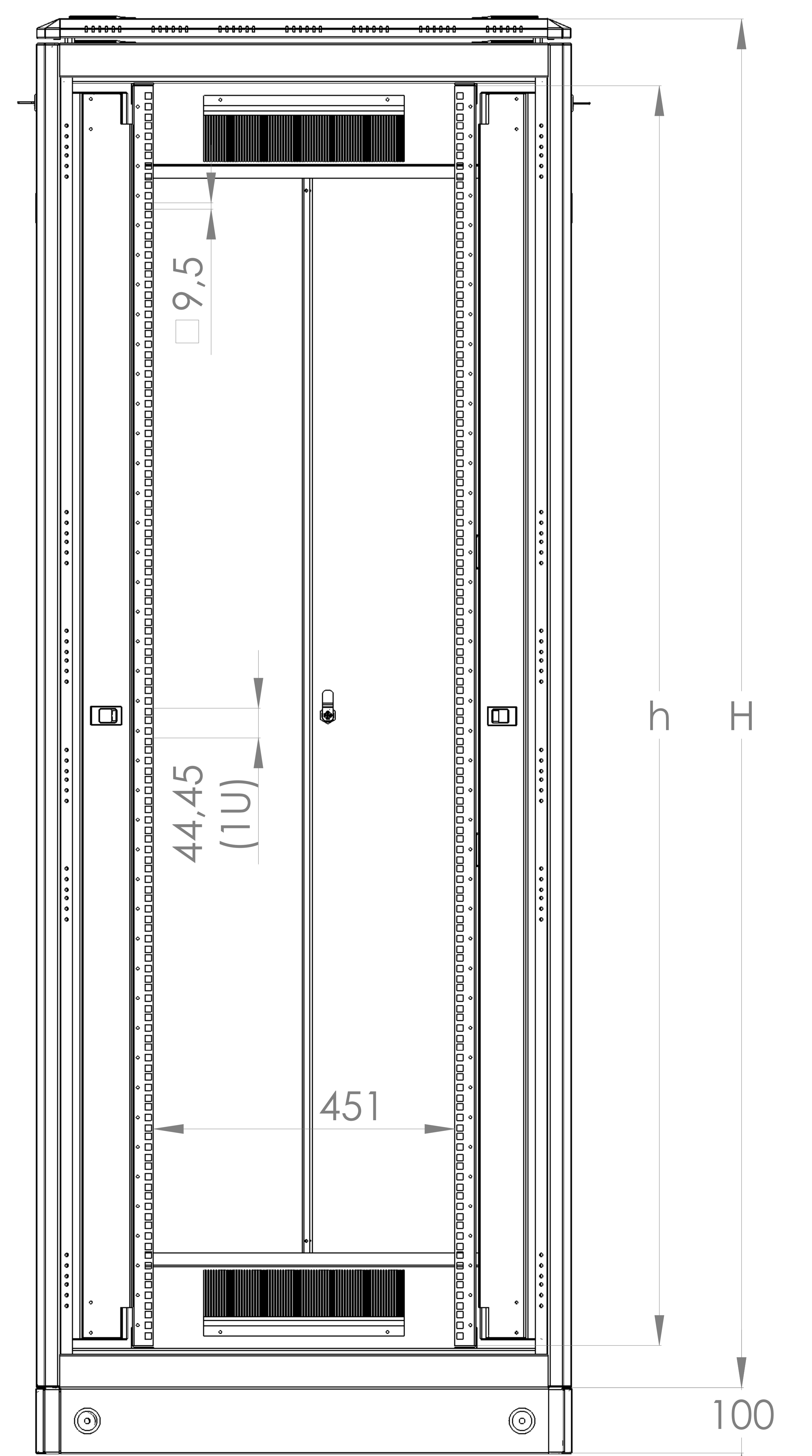

DIMENSIONS IN WIDTH
AND
HEIGHT